



CONTRACT COLLECTION 2010

Poomlighting

by LUCENTE®

La collezione PoomLighting raccoglie oggetti che interpretano in modo differente le funzioni e le forme della luce con prodotti moderni, pratici che illuminano in modo semplice gli ambienti che ci circondano.

I prodotti si caratterizzano per le loro forme pure ed essenziali, da prodotti a basso consumo con un alto grado di protezione e dall'alta funzionalità e praticità nell'installazione.

PoomLighting is a lighting collection which offers diversified interpretations of light through contemporary design and practical lamps which illuminate interiors that surround.

The collection is a line of products characterised by the shapes pure and essential, by low energy consumption offering a high protection grade, features all encompassed in a product easy and practical to install and mount.

La collezione PoomLighting rassemble des objets qui interprètent de façon différente les fonctions et les formes de la lumière grâce à des produits modernes, pratiques qui éclairent de façon simple les milieux qui nous entourent.

La collection est une ligne de produit que se caractérise par ses formes pures et essentielles, par des produits à faible consommation, possédant un degré de protection élevé et praticité d'installation.

Die Kollektion PoomLighting vereinigt Objekte, die auf eine andere Weise die Lichtfunktionen und Formen mit modernen und praktischen Produkten interpretieren, die auf schlichte Art und Weise die Räume beleuchten.

Die Kollektion ist eine Linie dass charakterisiert sich durch seine reinen und nüchternen Formen, durch Produkte mit geringem Verbrauch, mit einem hohen Grad an Sicherheit und hoher Funktionalität und Handlichkeit bei der Installation.

La colección PoomLighting reúne los objetos para interpretar en maneras diferentes las funciones y las formas de la luz con productos modernos, cómodos que iluminan en modo simple los ambientes que nos rodean.

La colección es una línea de productos con diseño juvenil. La línea se caracteriza por sus formas puras y esenciales, por productos de bajo consumo con un alto grado de protección, alta funcionalidad y comodidad en la instalación.

CONTRACT COLLECTION 2010

P o o m l i g h t i n g

index

Collections >>> 5

Technical and bathroom light >>> 165

Easy light >>> 190

AIDA	97	GAIA	145	OMNI	198
AI-PI	169	GALASSIA	199	ONSEN	185
AI-PI INOX	167	GEA	123	OSTER	187
ALTEA	47	GEO	207	POCKET	195
ANKE	61	GINGER	5	POSI	25
ARGO	137	GLEN	107	POSI_WAVE	25
ASTRATTA	83	HOOK	194	QUADRA	203
BAAN	121	HOT	125	RANDA	163
BELL	79	HUT	191	RHA	35
BOREALE	99	IDROO	179	RING	197
BRACKET	202	IRISH	206	ROCK	51
BREAK	208	ISOTTA	164	SAIL	153
BRIGHT	141	JEF	115	SAMURAI	153
CLUB	81	JOLE	151	SATURNO	204
DAMA	205	KLYPTA	149	SORRISO	204
DIABOLA	208	KOMET	193	SQ_EASY	175
DIECIDIECI	192	LINA	55	SQUARE	91
DOMINO	133	LUNA	156	STADIUM	157
DUPLEX	21	METI	41	TAIA	159
ELLA	75	MIZAR	201	TREE	210
EMY	65	MOON	207	TRIANGOLI	205
EOS	173	NAUTI	69	TRIM	85
FLOAT	183	NUVOLA	153	TWIST	89
FLUONIGHT	129	O_LAMP	103	VIDEO	200
FRAC	206	OLLY	31	VIDRIO	209
GABBIA	211	OLYMPIA	13	ZAC	111



Lampade in tessuto disponibili nei colori avorio, rosso e nero. Struttura metallica verniciata.

Lampe en tissu disponible en couleur: ivoire, rouge ou noir. Structure vernis métallique.

Estructura metálica barnizada. Difusor en tejido rojo, negro y marfil. Disco inferior de PMMA serigrafiado en los modelos de techo y colgante.





Lamps in fabric available in ivory, red and black. Painted metal structure.

Leuchte in den Farben elfenbein, rot und schwarz erhältlich. Struktur in lackiertem Metall.





Светильник из негорючей ткани песочного, красного или черного цветов. Крашеное металлическое основание.



IP20  

Diffusore PMMA decorato
Decorated PMMA diffuser

	TYPE	ELECTR.	SOCKET	LAMP	CODE	FINISHING
SOFFITTO CEILING	GINGER-P1	105W	E27	A55 	T261	02 - 14 - 15
SOFFITTO CEILING	GINGER-P2	4x42W	E27	A55 	T262	02 - 14 - 15
SOSPENSIONE PENDANT	GINGER-S1	105W	E27	A55 	T263	02 - 14 - 15
SOSPENSIONE PENDANT	GINGER-S2	4x42W	E27	A55 	T264	02 - 14 - 15
TERRA FLOOR ARC	GINGER-TE	105W	E27	A55 	T285	02 - 14 - 15

Diffusore PMMA bianco
White finishing PMMA diffuser

SOFFITTO CEILING	GINGER-P1	105W	E27	A55 	T297	02 - 14 - 15
SOFFITTO CEILING	GINGER-P2	4x42W	E27	A55 	T298	02 - 14 - 15
SOSPENSIONE PENDANT	GINGER-S1	105W	E27	A55 	T299	02 - 14 - 15
SOSPENSIONE PENDANT	GINGER-S2	4x42W	E27	A55 	T300	02 - 14 - 15
TERRA FLOOR ARC	GINGER-TE	105W	E27	A55 	T301	02 - 14 - 15

TAVOLO TABLE	GINGER-TA	70W	E27	A55 	T265	02 - 14 - 15
TERRA FLOOR	GINGER-TE	105W	E27	A55 	T266	02 - 14 - 15



Diffusore PMMA decorato
Decorated PMMA diffuser

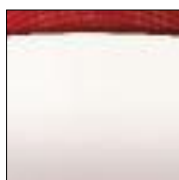

Diffusore PMMA bianco
White finishing PMMA diffuser



02 Avorio
Ivory



14 Rosso
Red

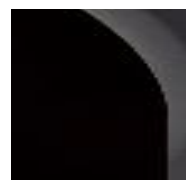

15 Nero
Black

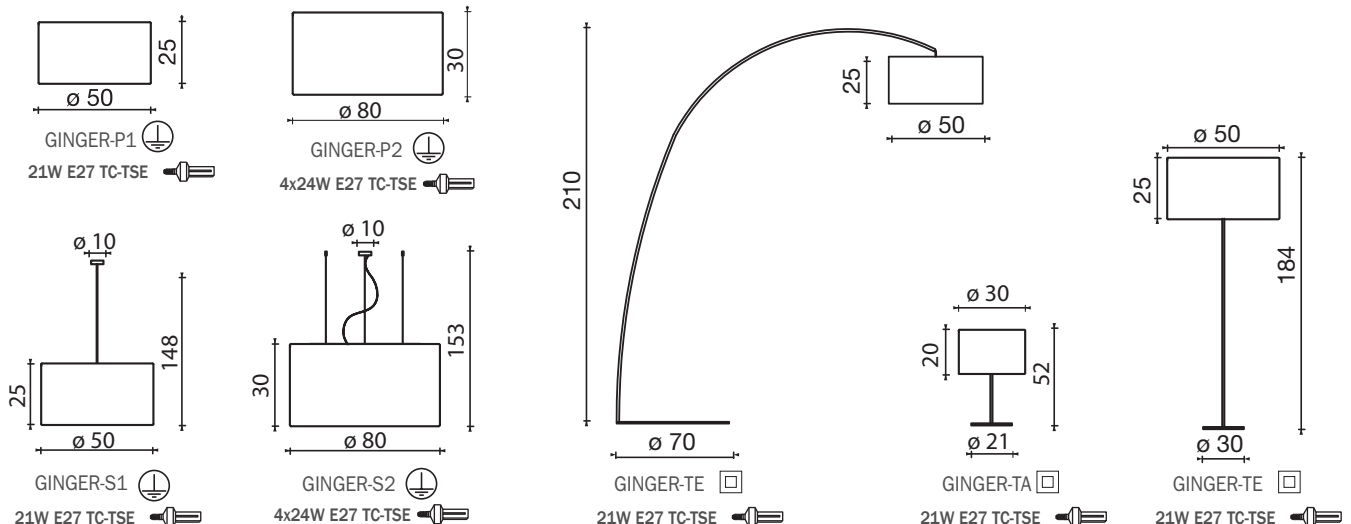

Ginger

Sospensione. Pendant lamp.









Ginger

Lampada da tavolo. Table lamp.







Struttura in metallo verniciato. Diffusore in vetro soffiato satinato bianco, ambrà e arancio. Alimentazione elettronica.

Painted metal fixture.
Satin blown glass diffuser available in white, amber and orange.
Electronic ballast.













Structure en métal verni.
Verre soufflé satiné: blanc, ambré et orange.
Ballast électronique.

Struktur aus lackiertem Metall. Streukörper aus mattem, geblasenem Glas und in weiss, bernsteinfarben und orange erhältlich. Elektronische Stromversorgung.

Estructura en metal lacado.
Vidrio soplado satinado: blanco, ámbar y naranja.
Ballast electrónico.

Окрашенное металлическое основание. Рассеиватель из дутого матового стекла может быть белого, песочного или оранжевого цвета. Модели, использующие энергосберегающие лампы снабжены электронным балластом.

IP20  

	TYPE	ELECTR.	SOCKET	LAMP		CODE	FINISHING
SOSPENSIONE PENDANT	OLYMPIA-S1	4x33W	G9	QT-13 	T165	16 - 01 - 04	
SOSPENSIONE PENDANT	OLYMPIA-S1	24W	G5	T5 	T166	16 - 01 - 04	
PARETE WALL	OLYMPIA-A1	4x33W	G9	QT-13 	T167	16 - 01 - 04	
PARETE WALL	OLYMPIA-A1	24W	G5	T5 	T168	16 - 01 - 04	
TERRA FLOOR	OLYMPIA-TE-1	4x33W	G9	QT-13 	T169	16 - 01 - 04	
TERRA FLOOR	OLYMPIA-TE-1	24W	G5	T5 	T170	16 - 01 - 04	
SOSPENSIONE PENDANT	OLYMPIA-S2	8x33W	G9	QT-13 	T171	16 - 01 - 04	
SOSPENSIONE PENDANT	OLYMPIA-S2	2x24W	G5	T5 	T172	16 - 01 - 04	
TERRA FLOOR	OLYMPIA-TE-2	8x33W	G9	QT-13 	T173	16 - 01 - 04	
TERRA FLOOR	OLYMPIA-TE-2	2x24W	G5	T5 	T174	16 - 01 - 04	
PARETE WALL	OLYMPIA-A	2x80W	R7s78mm	QT-DE 	T163	16 - 01 - 04	
TAVOLO TABLE	OLYMPIA-TA	2x33W	G9	QT-13 	T162	16 - 01 - 04	
TERRA FLOOR	OLYMPIA-TE	2x80W	R7s78mm	QT-DE 	T164	16 - 01 - 04	



16 Bianco
White



01 Ambra
Amber

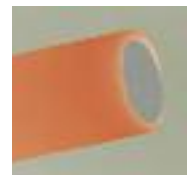

04 Arancio
Orange

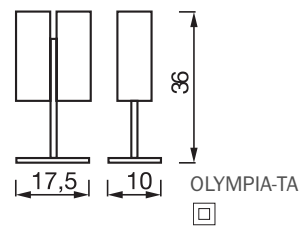
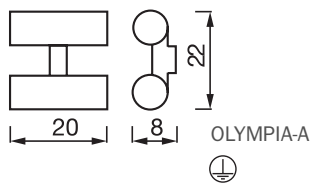
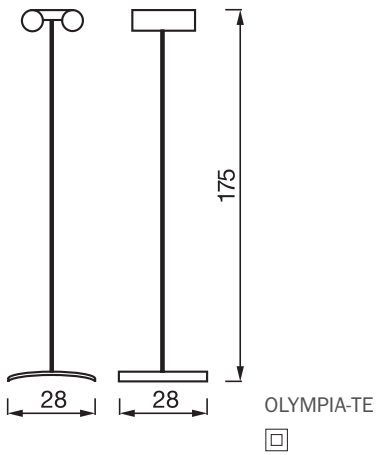
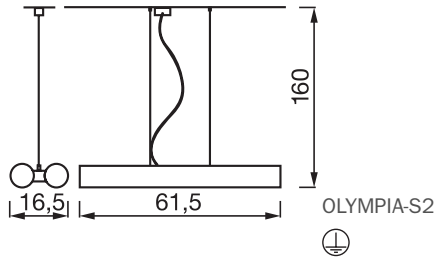
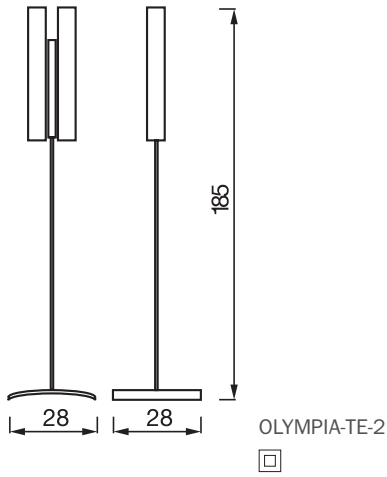
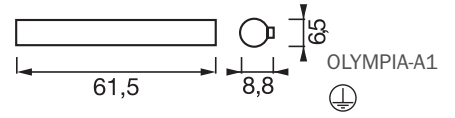
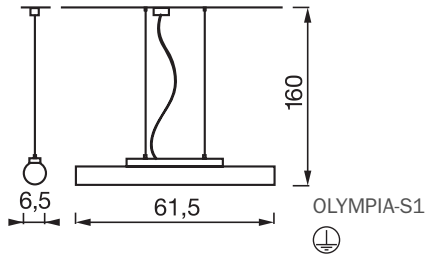
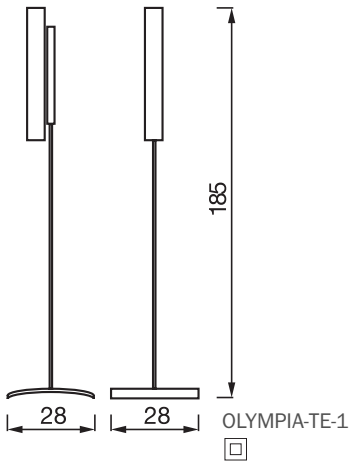



Olympia

Sospensione. Pendant lamp./Lampada da terra. Floor lamp.



Sospensione. Pendant lamp./Lampada da terra. Floor lamp. Olympia



Olympia

Lampada da tavolo. Table lamp. / Lampada da parete. Wall lamp.







Struttura in metallo verniciato, diffusori in vetro bianco oppure bianco-arancio.
Alimentazione elettronica.

Structure en métal verni.
Verres disponible dans le couleurs blanc ou blanc-orange. Ballast électronique.





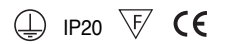

Estructura en metal lacado. Vidrio disponible en los colores blanco y blanco-naranja. Ballast electrónico.

Painted metal structure.
Diffusers available in white and white and orange. Electronic ballast.

Struktur aus lackiertem Metall. Weisssem oder Weisssem-Orange Glas. Elektronische Stromversorgung.

Окрашенное металлическое основание. Рассеиватели белого или белого и оранжевого цвета. Электронный балласт.



	TYPE	ELECTR.	SOCKET	LAMP	CODE	FINISHING
PARETE WALL	DUPLEX-A1	120W	R7s118mm	QT-DE 	T212	16 - 44
PARETE WALL	DUPLEX-A2	24W	G5	T5(T16) 	T213	16 - 44
SOSPENSIONE PENDANT	DUPLEX-S1	2x24W	G5	T5(T16) 	T214	16 - 44
SOSPENSIONE PENDANT	DUPLEX-S2	2x39W	G5	T5(T16) 	T215	16 - 44
SOSPENSIONE PENDANT	DUPLEX-S3	2x54W	G5	T5(T16) 	T216	16 - 44
TERRA FLOOR	DUPLEX-TE	230W	R7s118mm	QT-DE 	T217	16 - 44



16 Bianco-Bianco
White-White



44 Bianco-Arancio
White-Orange

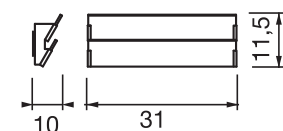

DUPLEX-A1



DUPLEX-A2

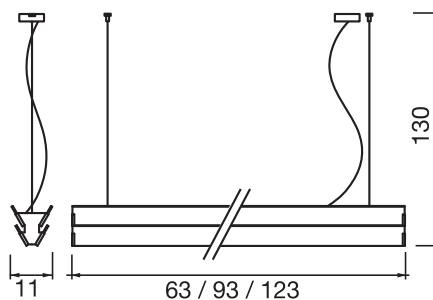

DUPLEX-S1 / S2 / S3

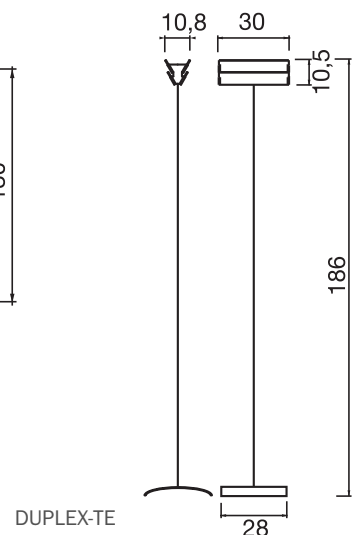

DUPLEX-TE

Duplex

Lampada da parete. Wall lamp.







Struttura in metallo verniciato grigio. Diffusore in termoplastico serigrafato.

Structure en métal verni gris. Diffuseur en thermoplastique sérigraphié.

Estructura en metal lacado gris. Difusor en termoplástico serigrafiado.

Grey painted metal structure. Diffuser in screen-printed thermoplastic.

Struktur aus grau lackiertem Metall. Lampenschirm aus Thermoplast mit Siebdruckmotiv.

Серое окрашенное металлическое основание. Рассеиватель из термопластика. Трафаретная печать.

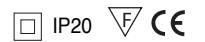

	TYPE	ELECTR.	SOCKET	LAMP	CODE	FINISHING
PARETE WALL	POSI-A	70W	E27	A55	T029	28
PARETE WALL	POSI W-A	70W	E27	A55	T195	28
SOSPENSIONE PENDANT	POSI-S	2x70W	E27	A55	T026	28
SOSPENSIONE PENDANT	POSI W-S	2x70W	E27	A55	T196	28
TAVOLO TABLE	POSI-TA	42W	E14	P45	T027	28
TAVOLO TABLE	POSI W-TA	42W	E14	P45	T194	28
TERRA FLOOR	POSI-TE	3x70W	E27	A55	T028	28
TERRA FLOOR	POSI W-TE	3x70W	E27	A55	T193	28



POSI

POSI WAVE

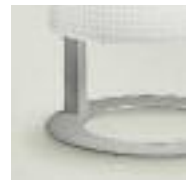

28 Grigio-argento
Silver Grey

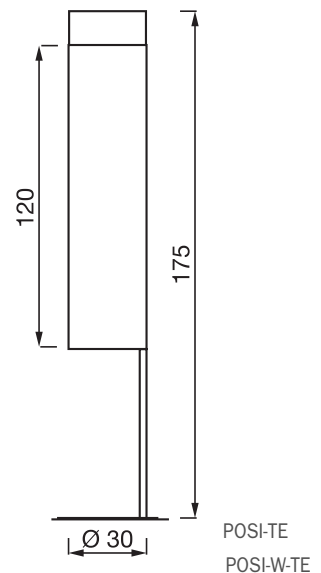
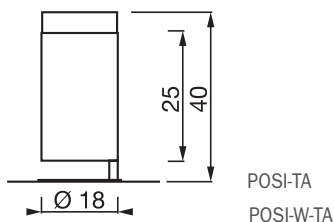
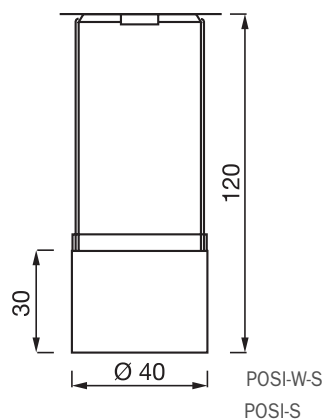
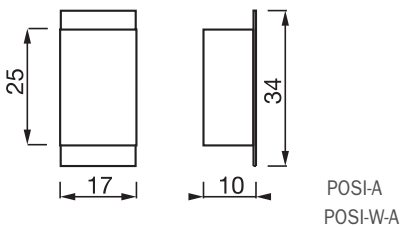

Posi Lampada da terra. Floor lamp.







Lampada da parete. Wall lamp. / Lampada da tavolo. Table lamp.

PosiWave





Struttura in metallo verniciato con particolari cromati. Diffusore in vetro soffiato satinato bianco. Alimentazione elettronica.

Structure en métal verni avec des particuliers chromés. Verre soufflé satiné blanc. Ballast électronique.









Estructura en metal lacado con detalles cromados. Difusor en vidrio soplado satinado blanco. Ballast electrónico.

Painted metal structure
White satin blown glass
diffuser. Electronic ballast.

Struktur aus lackiertem
Metall. Geblasenem Weiß
Glas. Elektronische
Stromversorgung.

Окрашенное металлическое
основание с хромированными
детальями. Белое матовое
стекло. Электронный балласт.

⊕ IP20 ⚡ CE

	TYPE	ELECTR.	SOCKET	LAMP	CODE	FINISHING
SOSPENSIONE PENDANT	OLLY-S1	18W	2G11	TCL 	T221	16
SOSPENSIONE PENDANT	OLLY-S2	24W	2G11	TCL 	T222	16
SOSPENSIONE PENDANT	OLLY-S3	36W	2G11	TCL 	T223	16
SOFFITTO CEILING	OLLY-P1	18W	2G11	TCL 	T218	16
SOFFITTO CEILING	OLLY-P2	24W	2G11	TCL 	T219	16
SOFFITTO CEILING	OLLY-P3	36W	2G11	TCL 	T220	16
TAVOLO TABLE	OLLY-TA1	48W	G9	QT-13 	T224	16
TAVOLO TABLE	OLLY-TA2	60W	G9	QT-14 	T225	16



16 Bianco
White

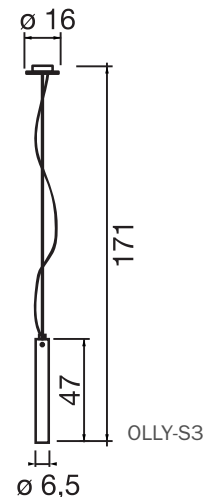
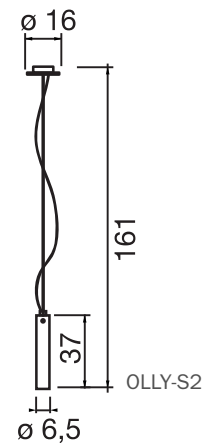
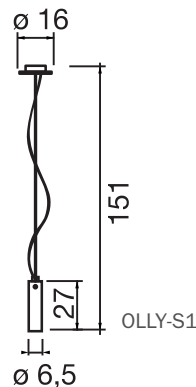
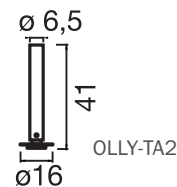
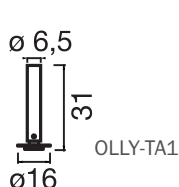
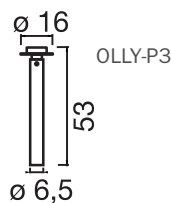
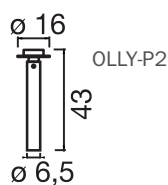
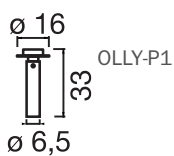







Struttura in alluminio pressofuso verniciato grigio e vetro trasparente. Riflettore orientabile.

Structure en aluminium verni et verrerie transparente. Réflecteur et diffuseur orientable.

Estructura en aluminio lacado gris y vidrio transparente. Reflector orientable.

Grey painted die-cast aluminium structure and clear glass diffuser. Adjustable reflector.

Struktur als grau lackiertem Aluminium und Glas. Reflektor und verstellbare zylindrischer.

Окрашенное в серый цвет алюминиевое основание. Прозрачное стекло. Настраиваемое направление света.

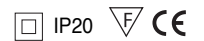

	TYPE	ELECTR.	SOCKET	LAMP	CODE	FINISHING
PARETE WALL	RHA-A	80W	R7s78mm	QT-DE	T015	28
PARETE WALL	RHA-AS	80W	R7s78mm	QT-DE	T017	28
SOFFITTO CEILING	RHA-P1	80W	R7s78mm	QT-DE	T018	28
SOFFITTO CEILING	RHA-P2	2x80W	R7s78mm	QT-DE	T019	28
SOSPENSIONE PENDANT	RHA-S2	2x80W	R7s78mm	QT-DE	T021	28
TERRA FLOOR	RHA-T1	80W	R7s78mm	QT-DE	T023	28

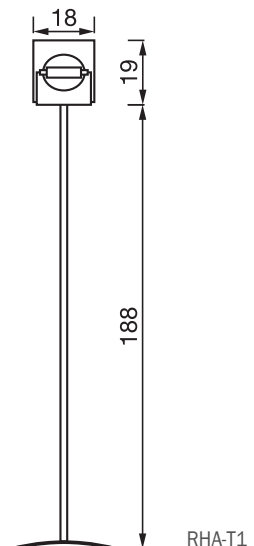
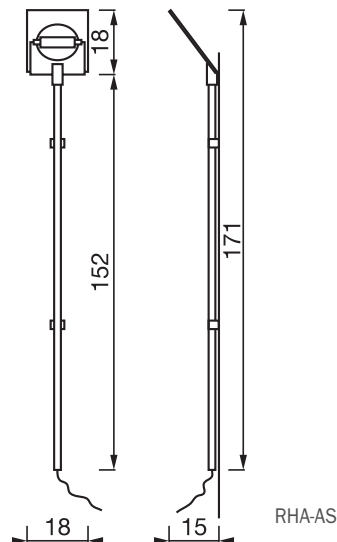
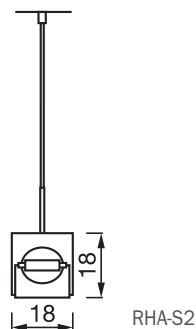
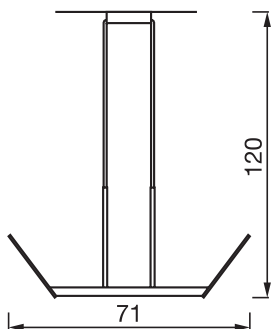
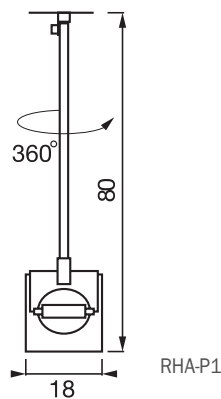
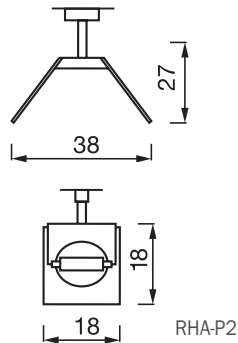
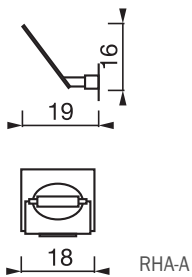

Rha

Lampada da parete. Wall lamp.





Rha

Sospensione. Pendant lamp.







Struttura orientabile in alluminio pressofuso verniciato grigio. Vetro trasparente. Sospensione con tige regolabile in altezza.

Structure en aluminium verni et verre transparente. Suspension avec tige réglable en hauteur, chromée.

Estructura en aluminio lacado. Vidrio transparente. Colgante con asta cromada ajustable.

Adjustable grey painted die-cast aluminium structure. Hanging lamp with height-adjustable chrome stem. Clear glass.

Struktur aus lackiertem Aluminium und Glas. Hängeleuchte, höhenverstellbar verchromt.

Крашенный алюминий и прозрачное стекло.

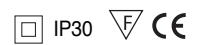

	TYPE	ELECTR.	SOCKET	LAMP	CODE	FINISHING
PARETE WALL	METI-A	60W	G9	QT-14	T001	28
PARETE WALL	METI-A	50W	GU10	QPAR	T002	28
SOFFITTO CEILING	METI-P	4x48W	G9	QT-13	T003	28
SOFFITTO CEILING	METI-P	4x50W	GU10	QPAR	T004	28
SOSPENSIONE PENDANT	METI-S	4x48W	G9	QT-13	T005	28
SOSPENSIONE PENDANT	METI-S	4x50W	GU10	QPAR	T006	28
TERRA FLOOR	METI-T	4x48W	G9	QT-13	T010	28
TERRA FLOOR	METI-T	4x50W	GU10	QPAR	T011	28



28 Grigio-argento
Silver Grey

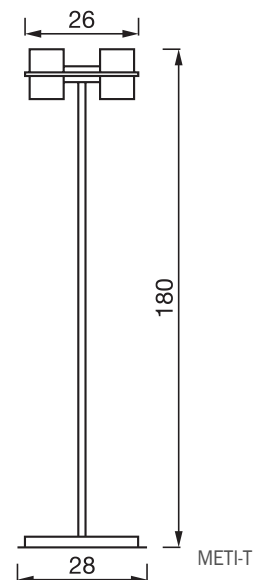
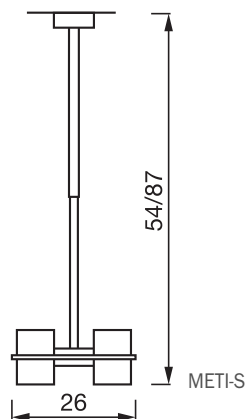
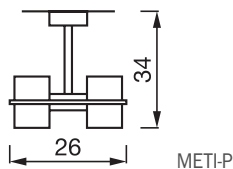
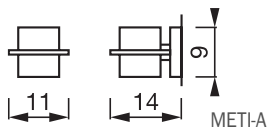

Meti

Lampada da parete. Wall lamp.

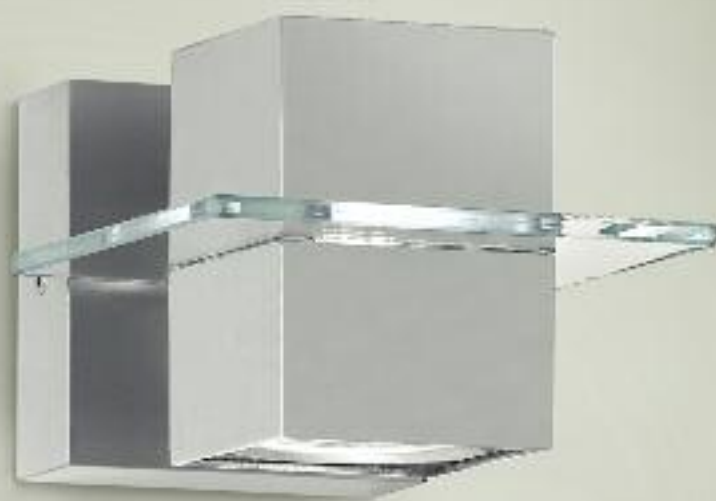



Meti

Sospensione. Pendant lamp. / Lampada da terra. Floor lamp.







Diffusore in vetro soffiato satinato. Struttura in metallo cromato e verniciato. Filtri colorati bianco, giallo e blu.

Satin blown glass diffuser. Chrome and aluminium painted metal structure. Filters available in white, yellow and blue.





Diffuseur en verre soufflé satiné. Structure en métal chromé et verni. Filtres teintés disponibles en blanc, jaune et bleu.

Lampenschirm aus mattem, mundgeblasenem Glas. Struktur aus verchromtem und lackiertem Metall. Bunte Filter in den Farben Weiß, Gelb und Blau.

Difusor en vidrio soplado satinado. Estructura en metal cromado y barnizado. Filtros colorados: blanco, amarillo y azul.

Матовое дутое стекло. Металлическое хромоное основание. Фильтры белого, желтого и синего цвета.

IP20  

	TYPE	ELECTR.	SOCKET	LAMP	CODE	FINISHING
PARETE WALL	ALTEA-A	42W	E27	A55 	T115	23
SOSPENSIONE PENDANT	ALTEA-S1	42W	E27	A55 	T116	23
SOSPENSIONE PENDANT	ALTEA-S2	70W	E27	A55 	T117	23
TERRA FLOOR	ALTEA-T	205W	E27	QT-32 	T118	23



23 Cromo
Chrome

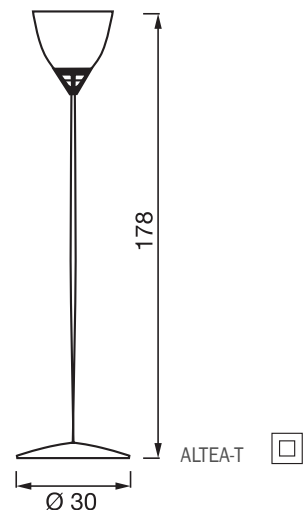
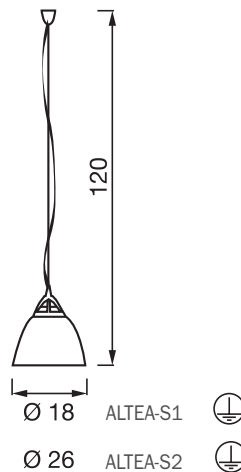
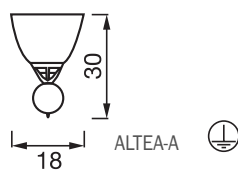

Altea

Sospensione. Pendant lamp.







Struttura in metallo cromato. Diffusore in vetro.

Structure en métal chromé. Diffuseurs en verre satiné.





Estructura en metal cromado. Difusor en vidrio satinado.

Chrome plated metal structure. Satin glass diffuser.

Struktur aus verchromtem Metall. Lampenschirme aus Mattglas.

Хромированное металлическое основание. Матовое стекло.

IP20  

	TYPE	ELECTR.	SOCKET	LAMP	CODE	FINISHING
PARETE WALL	ROCK-A	80W	R7s78mm	QT-DE 	T120	23
SOSPENSIONE PENDANT	ROCK-S2	80W	R7s78mm	QT-DE 	T121	23
SOSPENSIONE PENDANT	ROCK-S4	120W	R7s78mm	QT-DE 	T122	23
TAVOLO TABLE	ROCK-TA	33W	G9	QT-13 	T124	23
TERRA FLOOR	ROCK-TE	120W	R7s78mm	QT-DE 	T123	23



23 Cromo
Chrome

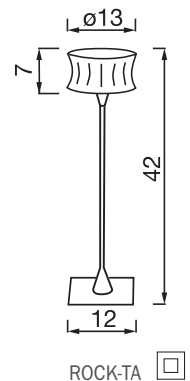
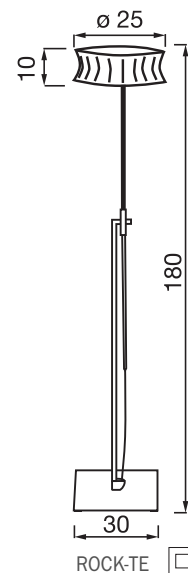
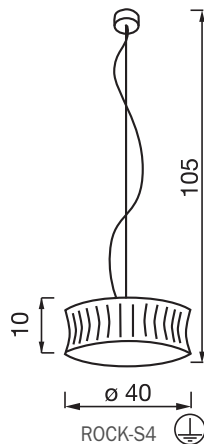
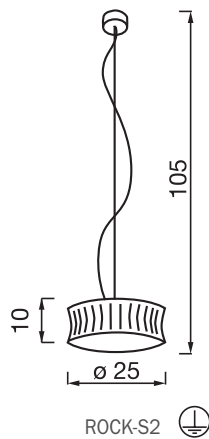
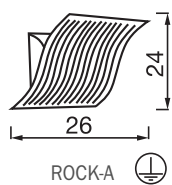

Rock

Lampada da parete. Wall lamp. / Sospensione. Pendant lamp.

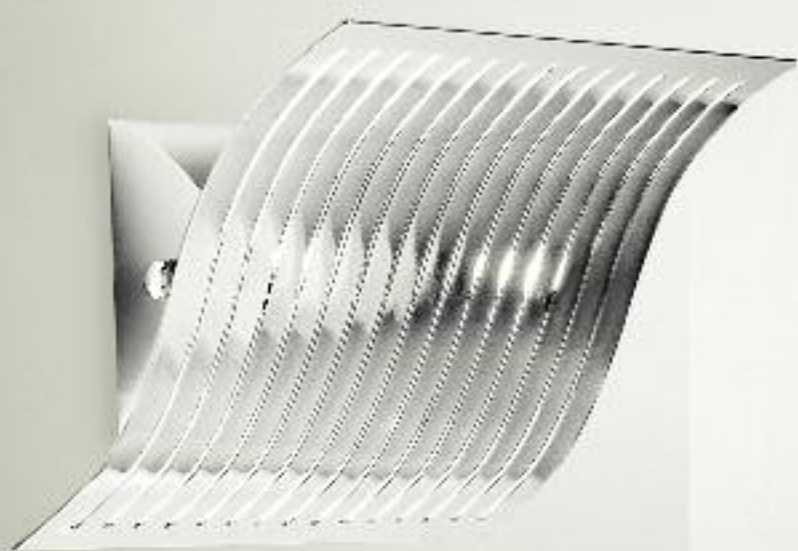

Lampada da tavolo. Table lamp. / Lampada da terra. Floor lamp..

Rock





Diffusore in vetro soffiato satinato. Struttura in metallo verniciato.

Diffuseur en verre soufflé satiné. Structure en métal verni.





Difusor en vidrio soplado satinado. Estructura en metal barnizado.

Satin blown glass diffuser. Painted metal structure.

Lampenschirm aus mattem, mundgeblasenem Glas. Struktur aus lackiertem.

Рассеиватель из матового дутого стекла белого, песочного или синего цвета. Окрашенное металлическое основание.

IP20 

	TYPE	ELECTR.	SOCKET	LAMP	CODE	FINISHING
PARETE WALL	LINA-A	42W	E27	A55 	P076	01 - 16 - 43
SOSPENSIONE PENDANT	LINA-S1	42W	E14	P45 	P077	01 - 16 - 43
SOSPENSIONE PENDANT	LINA-S2	70W	E27	A55 	P078	16
TAVOLO TABLE	LINA-TA	42W	E14	P45 	P079	01 - 16 - 43
TERRA FLOOR	LINA-TE	205W	E27	QT-32 	P080	16



01 Ambra
Amber



16 Bianco
White



43 Blu
Blue

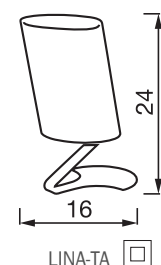
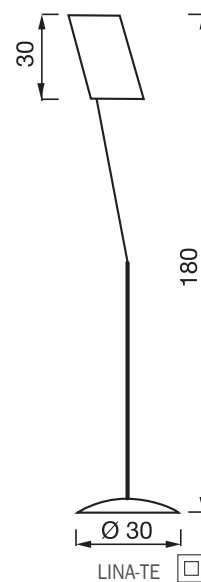
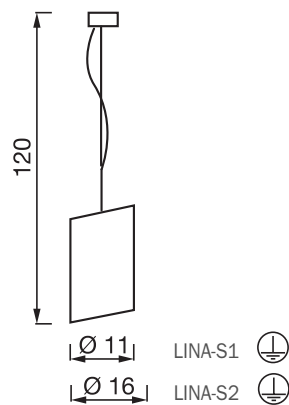
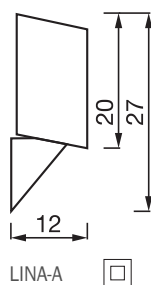





Lina

Lampada da tavolo. Table lamp./ Lampada da parete. Wall lamp.







Sospensioni in metallo verniciato nelle finiture:
- nero lucido esterno e interno bianco o arancio lucido;
- bianco lucido esterno e interno bianco o arancio lucido.
Montatura con finiture in cromo.

Suspensions en métal disponibles dans les versions suivantes :
 - Extérieur verni noir brillant et intérieur verni blanc ou orange brillant;
 - Extérieur verni blanc brillant et intérieur verni blanc ou orange brillant.
 Corps avec finitions chrome.



Lampara suspendida realizada en metal disponible en los siguientes acabados:
 - lacado negro brillo externamente e internamente blanco brillo o naranja brillo;
 - lacado blanco brillo externamente e internamente blanco brillo o naranja brillo.
 Soporte superior en acabado cromo.

Metal pendant lamps available in the following colours:
 - Glossy black (on the) outside and glossy white or orange inside;
 - Glossy white (on the) outside and glossy white or orange inside.
 Chrome details on the metal structure.

Pendelleuchte in Metall, erhältlich in folgenden Farben:
 - aussen schwarz glänzend und innen weiß oder orange;
 - aussen weiß glänzend und innen weiß oder orange.
 Metallteile in chrom.

Металлические, хромированные подвесные светильники могут быть следующих цветов;
 - чёрный снаружи, белый или оранжевый внутри.
 - белый снаружи, белый или оранжевый внутри.

⊕ IP20 ⚡ CE

	TYPE	ELECTR.	SOCKET	LAMP	CODE	FINISHING
SOSPENSIONE PENDANT	ANKE-S1	70W	E27	A55 	T286	16 - 07 - 15 - 06
SOSPENSIONE PENDANT	ANKE-S2	105W	E27	A55 	T287	16 - 07 - 15 - 06



16 Bianco White



07 Bianco/Arancio White/Orange



15 Nero/Bianco Black/White



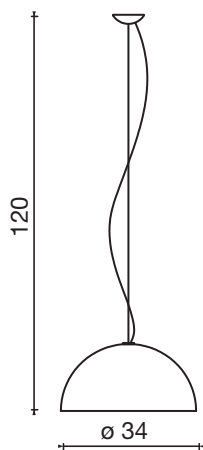

06 Nero/Arancio Black/Orange

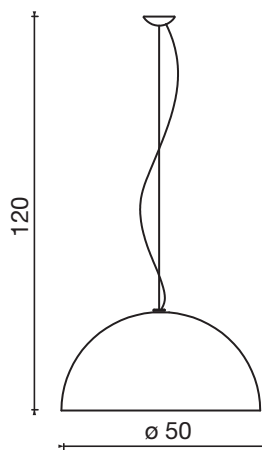

18W E27 DS GLOBE 

15W E27 DS MINI GLOBE 



18W E27 DS GLOBE 

Anke Sospensione. Pendant lamp.







Struttura in metallo verniciato e particolari cromati, diffusore in vetro satinato bianco.

Structure en métal verni avec des particuliers chromés. Diffuseur en verre satiné opale.





Estructura en metal lacado con detalles cromados. Difusor en vidrio satinado opal.

Grey painted metal structure. White satin glass diffuser.

Struktur aus lackiertem Metall. Glass seidenmatt Opal.

Окрашенное металлическое основание. Рассеиватель из белого матового стекла.

IP20  

	TYPE	ELECTR.	SOCKET	LAMP	CODE	FINISHING
PARETE WALL	EMY-A	70W	E27	A55 	T199	28
SOSPENSIONE PENDANT	EMY-S	70W	E27	A55 	T200	28
TAVOLO TABLE	EMY-TA	60W	G9	QT-14 	T198	28
TERRA FLOOR	EMY-TE	205W	E27	QT-32 	T197	28



28 Grigio-argento
Silver Grey

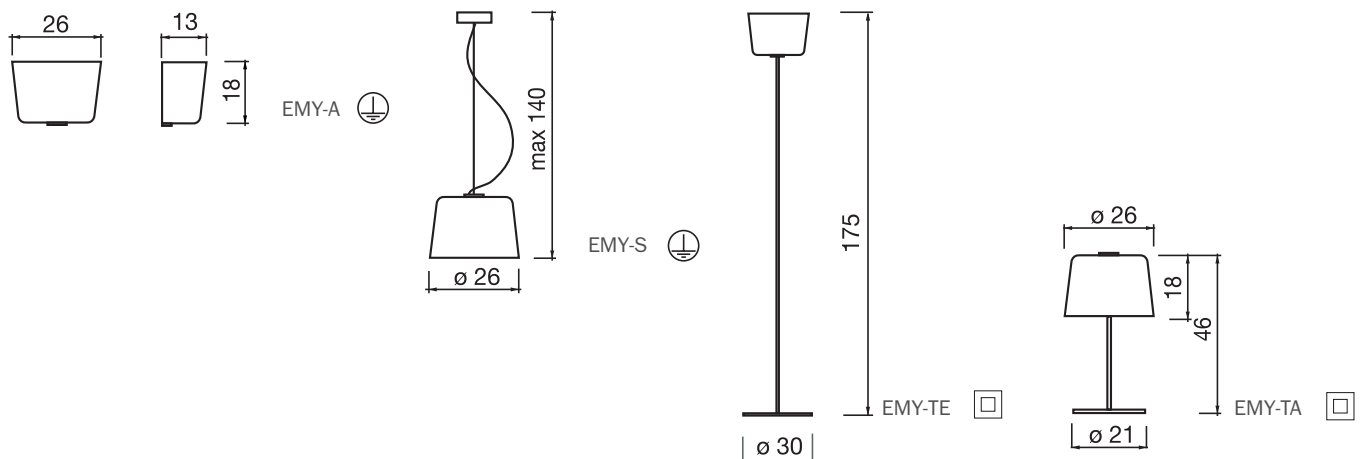

Emy

Lampada da tavolo. Table lamp. / Lampada da terra. Floor lamp.







NAU-A1C

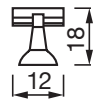

NAU-A1K IP40

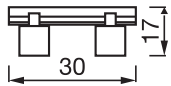

NAU-A2C

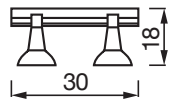

NAU-A2K IP40

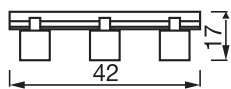

NAU-A3C

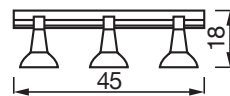

NAU-A3K IP40

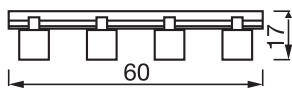

NAU-A4C

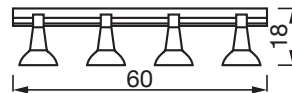

NAU-A4K IP40



NAU-S1C

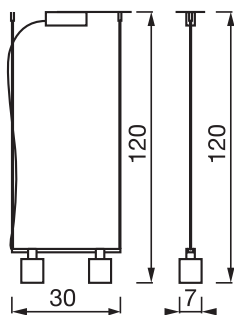

NAU-S2C

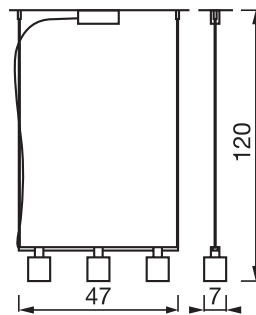

NAU-S3C

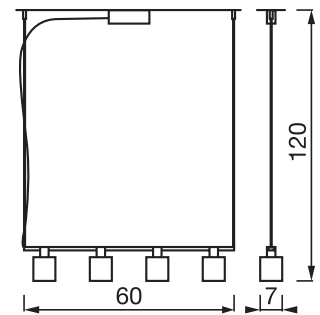

NAU-S4C



NAU-S1K IP40

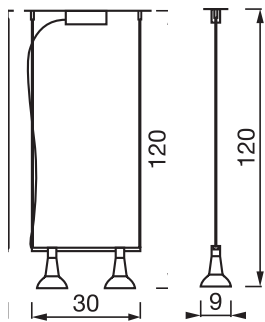

NAU-S2K IP40

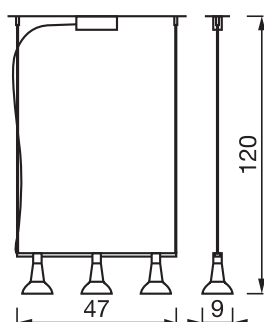

NAU-S3K IP40

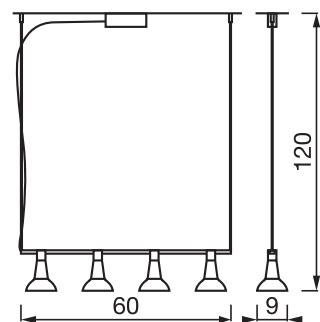

NAU-S4K IP40

Struttura metallica in cromo o nickel spazzolato. Diffusore in vetro soffiato trasparente, cilindrico o a campana.

Structure métallique en chrome ou nickel brossé. Diffuseur en verre soufflé transparent, cylindrique ou en forme de cloche.

Estructura metálica en cromo o níquel cepillado. Difusor de vidrio soplado transparente, cilíndrico o en forma de campana.

Metal structure available in chrome and brushed nickel. Clear blown glass diffuser.

Metallstruktur aus gebürsteten Chrom oder Nickel. Lampenschirm mit Zylinder - oder Glockenform aus mundgeblasenem Glas.

Металлическое основание в хrome или никеле. Прозрачное стекло.

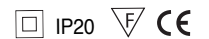

Vetro cilindrico Cylindrical glass

	TYPE	ELECTR.	SOCKET	LAMP	CODE	FINISHING
PARETE/SOFFITTO WALL/CEILING	NAU-A1C	48W	G9	QT-13	T040	23 - 34
PARETE/SOFFITTO WALL/CEILING	NAU-A2C	2x48W	G9	QT-13	T042	23 - 34
PARETE/SOFFITTO WALL/CEILING	NAU-A3C	3x48W	G9	QT-13	T044	23 - 34
PARETE/SOFFITTO WALL/CEILING	NAU-A4C	4x48W	G9	QT-13	T046	23 - 34
SOSPENSIONE PENDANT	NAU-S1C	48W	G9	QT-13	T050	23 - 34
SOSPENSIONE PENDANT	NAU-S2C	2x48W	G9	QT-13	T052	23 - 34
SOSPENSIONE PENDANT	NAU-S3C	3x48W	G9	QT-13	T054	23 - 34
SOSPENSIONE PENDANT	NAU-S4C	4x48W	G9	QT-13	T056	23 - 34

Vetro campana Bell glass

PARETE/SOFFITTO WALL/CEILING	NAU-A1K	48W	G9	QT-13	T041	23 - 34
PARETE/SOFFITTO WALL/CEILING	NAU-A2K	2x48W	G9	QT-13	T043	23 - 34
PARETE/SOFFITTO WALL/CEILING	NAU-A3K	3x48W	G9	QT-13	T045	23 - 34
PARETE/SOFFITTO WALL/CEILING	NAU-A4K	4x48W	G9	QT-13	T047	23 - 34
SOSPENSIONE PENDANT	NAU-S1K	48W	G9	QT-13	T051	23 - 34
SOSPENSIONE PENDANT	NAU-S2K	2x48W	G9	QT-13	T053	23 - 34
SOSPENSIONE PENDANT	NAU-S3K	3x48W	G9	QT-13	T055	23 - 34
SOSPENSIONE PENDANT	NAU-S4K	4x48W	G9	QT-13	T057	23 - 34



vetro cilindrico
cylindrical glass



vetro campana
bell glass



23 Cromo
Chrome



34 Nickel
spazzolato
Brushed
nickel



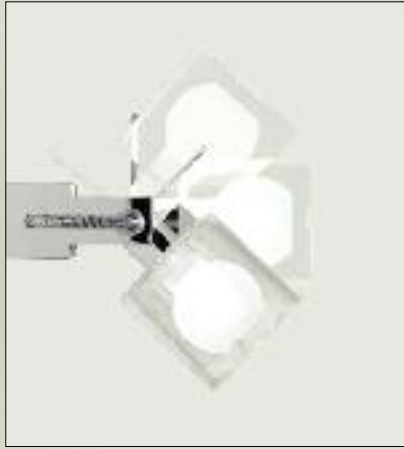







Struttura in metallo verniciato, diffusore in vetro satinato bianco, ambra o arancio.

Support en métal. Diffuseur en verre satiné: opale, ambre et orange.



Estructura en metal lacado gris. Difusor en vidrio satinado: opal, ámbar y anaranjado.

Grey painted metal structure. Satin glass available in amber, opal and orange.

Armaturo aus lackiertem Metall. Glass seidenmatt Opal, Bernstein oder Orange.

Окрашенное в серый цвет металлическое основание. Матовое стекло может быть белого, песочного или оранжевого цвета.

⊥ IP20 ⚡ CE

	TYPE	ELECTR.	SOCKET	LAMP	CODE	FINISHING
PARETE WALL	ELLA-A	70W	E27	A55 	T149	01 - 04 - 16
SOSPENSIONE PENDANT	ELLA-S	70W	E27	A55 	T150	01 - 04 - 16
SOSPENSIONE PENDANT	ELLA-S2	70W	E27	A55 	T230	01 - 04 - 16



01 Ambra
Amber



04 Arancio
Orange



16 Bianco
White



ELLA-A

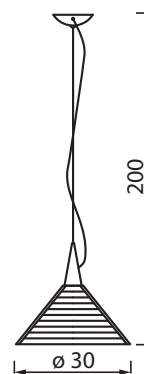

ELLA-S

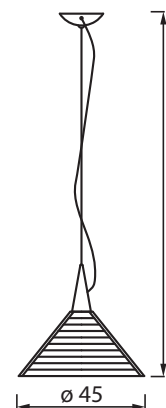

ELLA-S2







Struttura in metallo verniciato e particolari cromati, diffusori in vetro satinato: bianco, arancio, ambra e verde.

Structure en métal verni avec des particuliers chromés. Verres disponibles dans les couleurs blanc, orange, ambre et vert.

Estructura en metal lacado con detalles cromados. Difusor en vidrio satinado: opal, ámbar, naranja y verde.

Painted metal structure. Satin glass diffusers available in white, orange, amber and green.

Struktur aus lackiertem Metall. Glass seidenmatt Opal, Bernstein, Orange oder Grün.

Окрашенное металлическое основание. Матовые стеклянные плафоны могут быть белого, оранжевого, песочного и зеленого цвета.

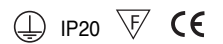

	TYPE	ELECTR.	SOCKET	LAMP	CODE	FINISHING
SOSPENSIONE PENDANT	BELL-S	70W	E27	A55	T201	16 - 01 - 04 - 17



16 Bianco
White



01 Ambra
Amber



04 Arancio
Orange



17 Verde
Green

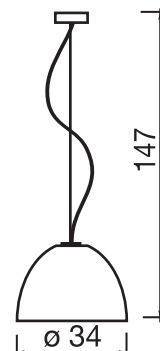



Struttura in metallo cromato, diffusori in vetro satinato.

Monture en métal chromé, diffuseurs en verre satiné.

Estructura en metal cromado. Difusor en vidrio satinado.

Chrome metal structure. Satin glass diffuser.

Verchromte Metallarmatur. Seidenmattes Glas.

Хромовое металлическое основание. Матовое стекло.

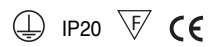

	TYPE	ELECTR.	SOCKET	LAMP	CODE	FINISHING
SOSPENSIONE PENDANT	CLUB-S	70W	E27	A55	T119	23



23 Cromo
Chrome

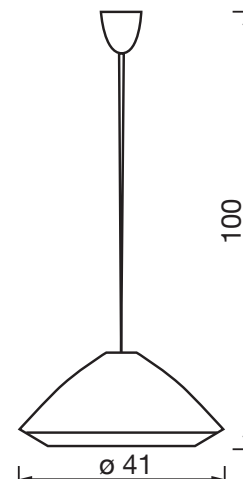

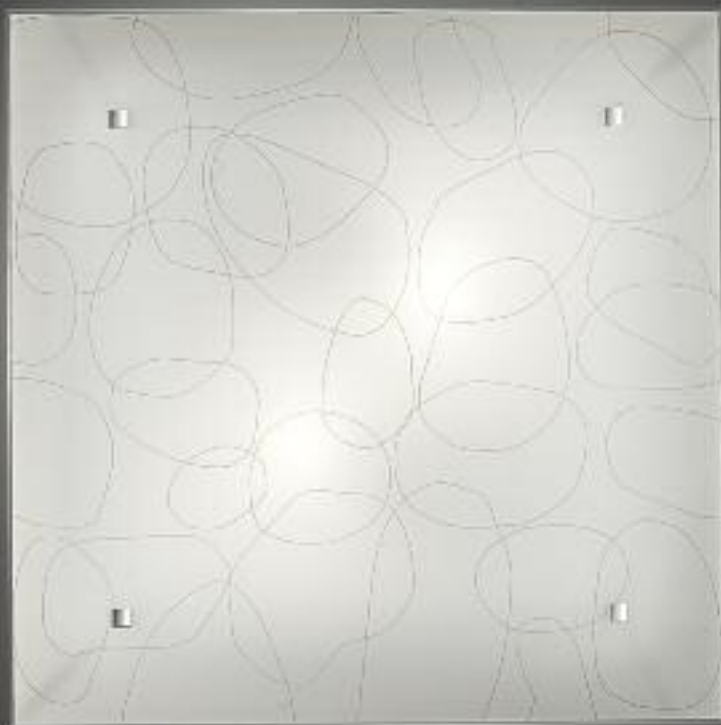

Lampada da parete o soffitto in due dimensioni, diffusore in vetro in lastra extrachiaro con finiture serigrafate. Struttura interna in metallo verniciata bianca. Alimentazione elettronica.

Applique ou plafonnier en deux dimensions, diffuseur en verre tiré extra clair et finitions sérigraphées. Structure interne en métal verni blanc. Alimentation électronique.

Lampara de pared o techo en dos dimensiones, difusor en cristal extraclaro con acabado serigrafiado. Estructura interna en metal barnizado blanco. Alimentación electrónica.

Wall and ceiling lamps available in two sizes. Glass diffuser with screen-printed details. White painted inside metal frame. Electronic ballast.

Wand und Deckenleuchte lieferbar in zwei Größen. Die Glasscheibe hat eine bedruckte Verzierung. Weiß lackierter Metallrahmen. Inklusive elektronischem Vorschaltgerät.

Рассеиватель из стекла. Электронный балласт.

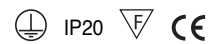

	TYPE	ELECTR.	SOCKET	LAMP	CODE	FINISHING
PARETE/SOFFITTO WALL/CEILING	ASTRATTA P1	2x28W	E27	A55	T289	SASSI
PARETE/SOFFITTO WALL/CEILING	ASTRATTA P1	2x18W	G24q-2	TC-DE	T290	SASSI
PARETE/SOFFITTO WALL/CEILING	ASTRATTA P2	2x42W	E27	A55	T291	SASSI
PARETE/SOFFITTO WALL/CEILING	ASTRATTA P2	2x26W	G24q-3	TC-DE	T292	SASSI
PARETE/SOFFITTO WALL/CEILING	ASTRATTA P1	2x28W	E27	A55	T293	ONDA
PARETE/SOFFITTO WALL/CEILING	ASTRATTA P1	2x18W	G24q-2	TC-DE	T294	ONDA
PARETE/SOFFITTO WALL/CEILING	ASTRATTA P2	2x42W	E27	A55	T295	ONDA
PARETE/SOFFITTO WALL/CEILING	ASTRATTA P2	2x26W	G24q-3	TC-DE	T296	ONDA



Sassi

Onda

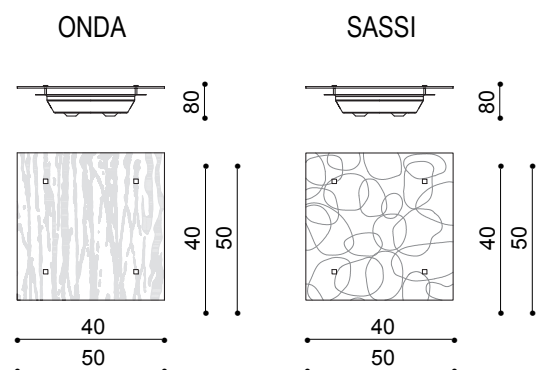



**Diffusore in vetro curvato.
Struttura in metallo
verniciata bianca.
Alimentazione elettronica.**

Diffuseur en verre courbé.
Structure en métal blanc.
Ballast électronique.

Difusor en vidrio curvado.
Estructura metálica
barnizada blanca.
Ballast electrónico.

Curved glass diffuser.
White metal structure.
Electronic ballast.

Diffusor im gekurvtem Glas.
Struktur in weiss lackiertem
Metall. Elektronische
Stromversorgung.

Стеклянный рассеиватель,
белое металлическое
основание.
электронным балластом.

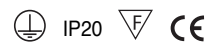

	TYPE	ELECTR.	SOCKET	LAMP	CODE	FINISHING
PARETE WALL	TRIM-A1	26W	G24q-3	TC-DE	T270	16
PARETE WALL	TRIM-A1	24W	E27	TC-TSE	T281	16
PARETE WALL	TRIM-A2	36W	2G11	TC-L	T271	16
PARETE WALL	TRIM-A2	2x24W	E27	TC-TSE	T282	16
PARETE/SOFFITTO WALL/CEILING	TRIM-P1	2x42W	E27	A55	T272	16
PARETE/SOFFITTO WALL/CEILING	TRIM-P1	2x26W	G24q-3	TC-DE	T273	16
PARETE/SOFFITTO WALL/CEILING	TRIM-P1	38W	GR10q	TC-DDE	T274	16

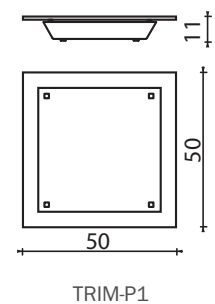
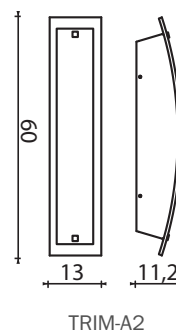
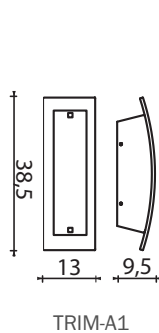







**Struttura in metallo verniciato.
Diffusore curvato in vetro serigrafato bianco.**

Structure en métal verni.
Diffuseur en verre courbé sérigraphié satiné.









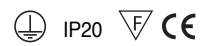

Estructura en metal lacado. Vidrio curvado serigrafado satinado.

Grey painted metal structure. Glass diffuser.

Struktur aus lackiertem Metall. Glas seidenmatt, Siebdruck-Dekor.

Окрашенное в серый цвет основание. Рассеиватель из стекла.



	TYPE	ELECTR.	SOCKET	LAMP	CODE	FINISHING
PARETE WALL	TWIST-A1	18W	2G11	TCL 	T202	28
PARETE WALL	TWIST-A1	70W	E27	QT-32 	T203	28
PARETE WALL	TWIST-A2	36W	2G11	TCL 	T204	28
PARETE WALL	TWIST-A2	3x70W	E27	QT-32 	T205	28
PARETE WALL	TWIST-A3	55W	2G11 ^{electronic ballast}	TCL 	T206	28
PARETE WALL	TWIST-A3	4x70W	E27	QT-32 	T207	28
PARETE WALL	TWIST-4	2x18W	2G11	TCL 	T208	28
PARETE WALL	TWIST-4	2x70W	E27	QT-32 	T209	28
PARETE WALL	TWIST-5	2x24W	2G11	TCL 	T210	28
PARETE WALL	TWIST-5	2x70W	E27	QT-32 	T211	28



28 Grigio-argento
Silver Grey

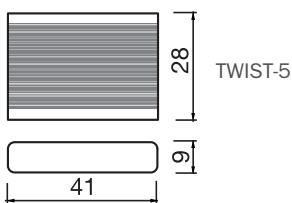
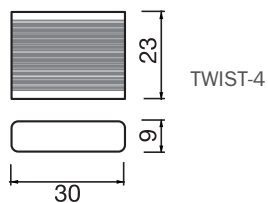
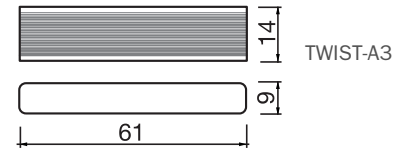
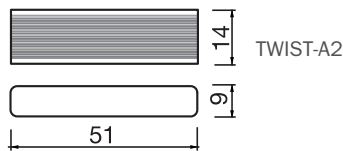
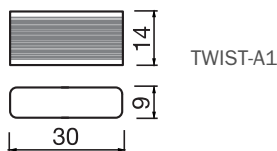



Struttura in metallo verniciato. Diffusore in vetro satinato.

Structure en métal vernis. Diffuseur en verre satiné.

Estructura de metal lacado. Vidrio satinado.

Painted metal structure. Satin glass diffuser.

Struktur aus lackiertem Metall. Streukörper aus mattem Glas.

Окрашенное металлическое основание. Рассеиватель из матового стекла.

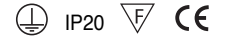

	TYPE	ELECTR.	SOCKET	LAMP		CODE	FINISHING
PARETE/SOFFITTO WALL/CEILING	SQUARE-3	42W	E27	A55		P030	16 - 28
PARETE/SOFFITTO WALL/CEILING	SQUARE-3	16W	GR8	TC-DD		P225	16 - 28
PARETE/SOFFITTO WALL/CEILING	SQUARE-3	2x18W	G24d-2	TC-D		P226	16 - 28
PARETE/SOFFITTO WALL/CEILING	SQUARE-4	2x42W	E27	A55		P031	16 - 28
PARETE/SOFFITTO WALL/CEILING	SQUARE-4	38W	GR10q	TC-DDE		P227	16 - 28
PARETE/SOFFITTO WALL/CEILING	SQUARE-4	2x36W	2G10	TC-F		P228	16 - 28
PARETE/SOFFITTO WALL/CEILING	SQUARE-4	2x24W	2G10	TC-F emergency 1h		P242	16 - 28
PARETE/SOFFITTO WALL/CEILING	SQUARE-5	2x9W	G23	TC-S		P243	16 - 28
PARETE/SOFFITTO WALL/CEILING	SQUARE-6	24W	2G11	TC-L		P244	16 - 28
PARETE/SOFFITTO WALL/CEILING	SQUARE-7	2x36W	2G11	TC-L		P245	16 - 28
PARETE/SOFFITTO WALL/CEILING	SQUARE-7	2x24W	2G11	TC-L emergency 1h		P246	16 - 28
PARETE/SOFFITTO WALL/CEILING	SQUARE-8	3x42W	E27	A55		P254	16 - 28
PARETE/SOFFITTO WALL/CEILING	SQUARE-8	3x36W	2G11	TC-L		P255	16 - 28
PARETE/SOFFITTO WALL/CEILING	SQUARE-8	3x36W	2G11	TC-L emergency 1h		P256	16 - 28

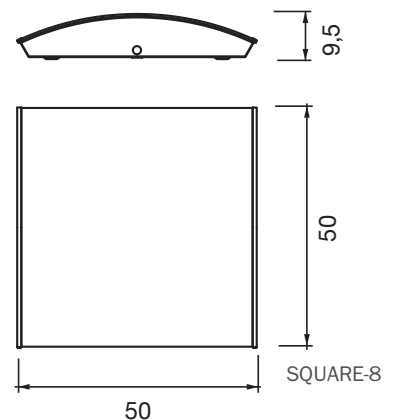
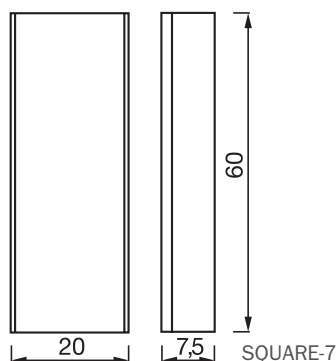
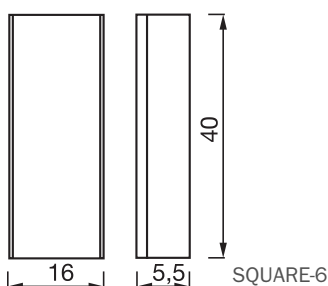
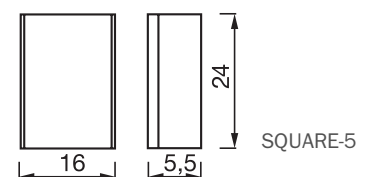
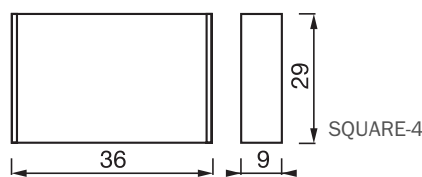
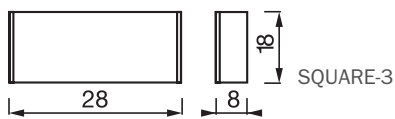

Square

Lampada da parete e soffitto. Wall and ceiling lamp.



Lampada da parete e soffitto. Wall and ceiling lamp.

Square



Square

Lampada da parete e soffitto. Wall and ceiling lamp.







Struttura in metallo verniciato. Diffusore in vetro satinato.

Structure en métal laqué, diffuseur en verre satiné.

Estructura en metal barnizado. Vidrio satinado.

Painted metal structure. Satin glass diffuser.

Armatur aus lackiertem Metall, praegtes Glas seidenmatt.

Окрашенное металлическое основание. Матовое стекло.

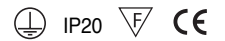

	TYPE	ELECTR.	SOCKET	LAMP		CODE	FINISHING
SOFFITTO CEILING	AIDA-P3	2x28W	E14	P45		T090	28
SOFFITTO CEILING	AIDA-P3	80W	R7s78mm	QT-DE		T091	28
SOFFITTO CEILING	AIDA-P4	2x42W	E27	A55		T092	28
SOFFITTO CEILING	AIDA-P4	120W	R7s78mm	QT-DE		T093	28



28 Grigio-argento
Silver Grey

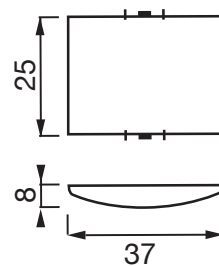

AIDA-P3

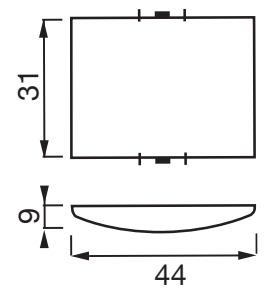

AIDA-P4



Struttura in metallo verniciato grigio, vetro soffiato trasparente. Diffusore interno in vetro satinato o termoplastico opale.

Structure en métal verni gris, verre soufflé transparent. Diffuseur interne en verre satiné ou thermoplastique opale.





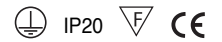

Estructura en metal lacado gris y vidrio soplado transparente. Vidrio interno satinado arenado o termoplástico blanco.

Grey painted metal structure, clear blown glass. Internal diffuser in satin glass or opal thermoplastic.

Struktur aus grau lackiertem Metall und mundgeblasenem Glas. Interner Lampenschirm aus Mattglas oder mattem Thermoplast.

Окрашенное в серый цвет металлическое основание. Прозрачное дутое стекло.



	TYPE	ELECTR.	SOCKET	LAMP	CODE	FINISHING
SOFFITTO CEILING	BOREALE-T3	80W	R7s78mm	QT-DE 	T060	28
SOFFITTO CEILING	BOREALE-T4	120W	R7s78mm	QT-DE 	T061	28
SOFFITTO CEILING	BOREALE-03	16W	GR8	TC-DD 	T062	28
SOFFITTO CEILING	BOREALE-03	2x9W	G23	TCS 	T063	28
SOFFITTO CEILING	BOREALE-04	28W	GR8	TC-DD 	T064	28
SOFFITTO CEILING	BOREALE-04	26W	G24d-3	TC-D 	T065	28



28 Grigio-argento
Silver Grey

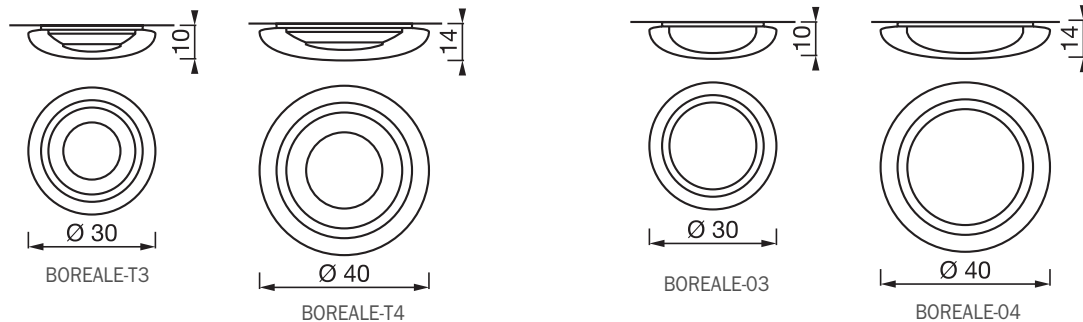

Boreale

Lampada da parete e soffitto. Wall and ceiling lamp.







Diffusore in vetro soffiato opale. Base in pressofusione di alluminio. Meccanismo di inserimento e disinserimento del diffusore trasparente in termoplastico.

Diffuseur en verre soufflé opale satiné. Mécanisme de fixation et de élèvement du globe en matériel thermoplastique transparent. Base en aluminium.

Esfera en vidrio soplado opal satinado. Mecanismo de fijación de la esfera en termoplástico transparente. Estructura en aluminio.

Satin opal blown glass diffuser with clear thermoplastic ring for fixing to the base. Aluminium base.

Geblasenem Opalglas. Aufsetz- und Abnehmmechanismus der Kugel aus transparentem thermoplastischen Material. Struktur aus Aluminium.

Матовое дутое стекло. Алюминиевое основание.

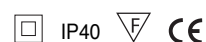

	TYPE	ELECTR.	SOCKET	LAMP	CODE	FINISHING
PARETE/SOFFITTO WALL/CEILING	O-LAMP	42W	E27	A55	T152	28
TAVOLO TABLE	O-LAMP	42W	E27	A55	T153	28



28 Grigio-argento
Silver Grey

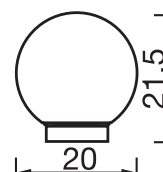
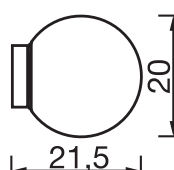
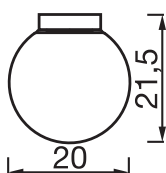

O_Lamp

Lampada da parete e soffitto. Wall and ceiling lamp.







**Struttura metallica
nei colori: bianco e
grigio argento.**

Structure métallique
laquée blanc ou gris
argent.

Estructura metálica en
los colores blanco o
gris plateado.

Metal structure in
white or silver grey.

Basis aus Metall,
lackiert weiß
oder silbergrau.

Металлическое
основание белого или
серебряного цветов.

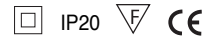

	TYPE	ELECTR.	SOCKET	LAMP	CODE	FINISHING
PARETE WALL	GLEN	160W	R7s118mm	QT-DE 	T288	16 - 28



16 Bianco
White



28 Grigio-argento
Silver-grey

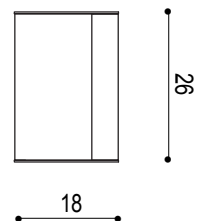

Glen

Lampada da parete. Wall lamp.







Struttura in metallo.
Diffusore in PMMA opalino.
Alimentazione elettronica.

Structure en métal.
 Diffuseur en PMMA opalin.
 Ballast électronique.

Estructura de metal.
 Difusor en PMMA opalino.
 Ballast electrónico.





Metal structure.
 Opal PMMA satin acrylic
 diffuser. Electronic ballast.

Struktur aus Metall.
 Weiss PMMA diffuser.
 Elektronische Stromversorgung.

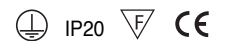
Металлическое основание в
 хроме или никеле. Матовый
 акриловый рассеиватель.
 Электронный балласт.

La serie è disponibile nella versione in emergenza da 1H o da 3H.
 The range is available with emergency working 1H or 3H.



	TYPE	ELECTR.	SOCKET	LAMP	CODE	FINISHING
SOFFITTO CEILING	ZAC-P3	2x24W	2G11	TCL 	T240	23 - 34
SOFFITTO CEILING	ZAC-P3	2x24W	2G11	TCL 	T275	16 - 28
SOFFITTO CEILING	ZAC-P4	2x36W	2G11	TCL 	T241	23 - 34
SOFFITTO CEILING	ZAC-P4	2x36W	2G11	TCL 	T276	16 - 28



23 Cromo
 Chrome



34 Nichel spazzolato
 Brushed nickel



16 Bianco
 White



28 Grigio-argento
 Silver grey

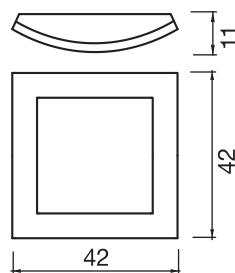

ZAC-P3

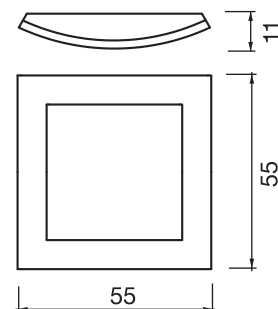

ZAC-P4



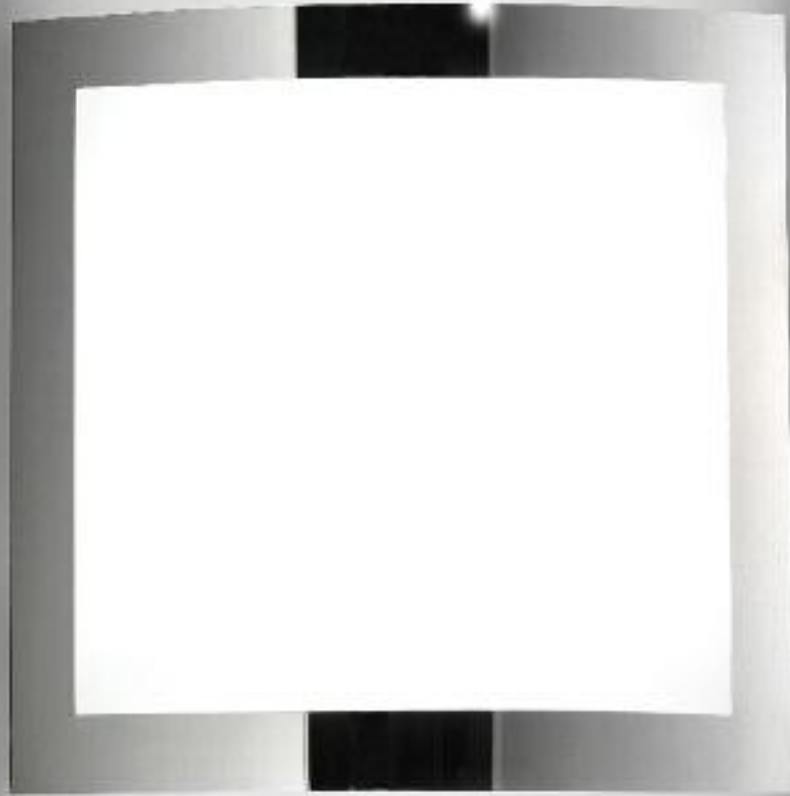



Riflettore frontale in metallo verniciato bianco, cromo o nickel spazzolato. Jef A1, A2, A3 con doppio vetro di protezione temprato.

Structure en métal vernie blanc, chrome brillant ou nickel brossé. Double diffuseur en verre pour la Jef A1, A2, A3.

Reflector frontal de metal níquel cepillado, cromo o barnizado blanco. Jef A1, A2, A3 con doble vidrio de protección templado.

Metal reflector available in white painted, chrome or brushed nickel. Top and bottom tempered glass diffusers on Jef A1, A2 and A3.

Struktur aus Metall in weiss, glänzend verchromt oder Nickel geburstet. Doppel glas für Jef A1, A2, A3.

Металлическое основание в никеле, хrome или белого цвета В моделях JEF A1, A2, A3 рассеиватели из закаленного стекла.

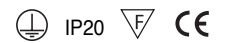

	TYPE	ELECTR.	SOCKET	LAMP	CODE	FINISHING
PARETE WALL	JEF-A1	48W	G9	QT-13	T252	16 - 23 - 34
PARETE WALL	JEF-A2	80W	R7s78mm	QT-DE	T253	16 - 23 - 34
PARETE WALL	JEF-A3	26W	G24d-3	TC-D	T254	16 - 23 - 34
PARETE WALL	JEF-1	75W	GU10	QPAR	T255	16 - 23 - 34
PARETE WALL	JEF-2	2x75W	GU10	QPAR	T256	16 - 23 - 34



16 Bianco White



23 Cromo Chrome



34 Nichel spazzolato Brushed nickel

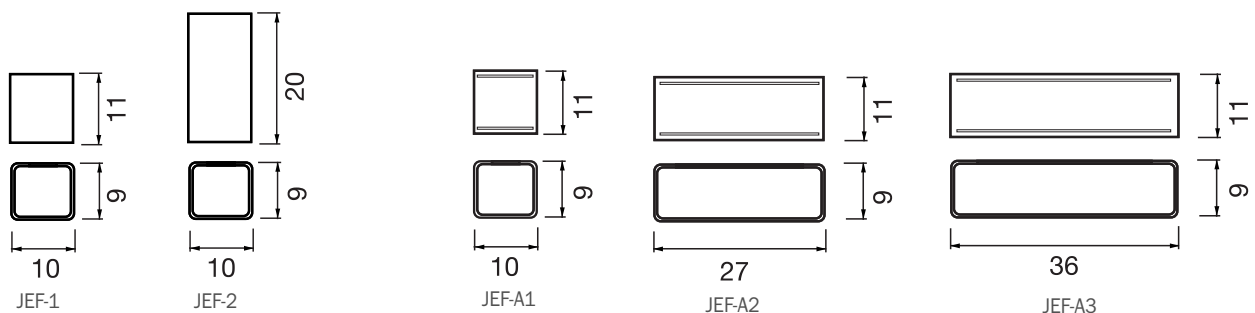









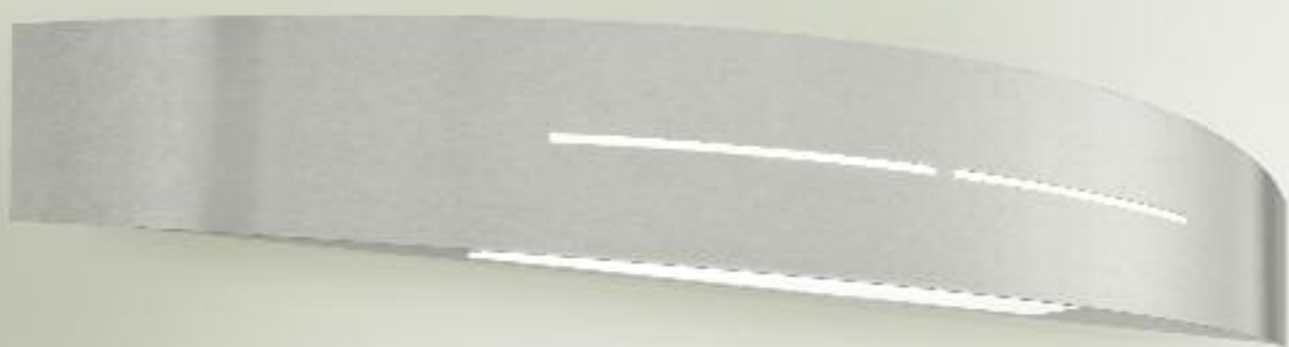

Riflettore in acciaio satinato. Struttura in metallo verniciato. Alimentazione elettronica.

Structure en métal verni.
Réflecteur de acier.
Ballast électronique.







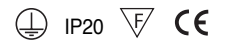

Reflector de acero satinado. Estructura de metal lacado.
Ballast electrónico.

Stainless steel reflector.
Painted metal structure.
Electronic ballast.

Reflektor aus mattem Stahl. Struktur aus lackiertem Metall.
Elektronische Stromversorgung.

Матовый отражатель из нержавеющей стали.
Окрашенное металлическое основание.
Электронный балласт.



	TYPE	ELECTR.	SOCKET	LAMP	CODE	FINISHING
PARETE WALL	BAAN-LINEA-1	70W	E27	QT-32 	T277	25
PARETE WALL	BAAN-LINEA-1	26W	G24q-3	TC-DE 	T278	25
PARETE WALL	BAAN-FORI-1	70W	E27	QT-32 	T279	25
PARETE WALL	BAAN-FORI-1	26W	G24q-3	TC-DE 	T280	25
PARETE WALL	BAAN-LINEA-2	2x28W	E14	B35 	T175	25
PARETE WALL	BAAN-LINEA-2	24W	2G11	TCL 	T176	25
PARETE WALL	BAAN-FORI-2	2x28W	E14	B35 	T177	25
PARETE WALL	BAAN-FORI-2	24W	2G11	TCL 	T178	25



25 Acciaio satinato
Satinated steel





Struttura in metallo verniciato grigio e schermo frontale in cromo lucido. Disponibile senza o con vetro sabbiato.

Structure en métal verni gris et écran frontal en chrome brillant. Disponible dans la version avec verre sablé ou sans verre.





Estructura de metal barnizado gris y protección frontal cromada. Disponible en versión con vidrio arenado o sin vidrio.

Grey painted metal structure and chrome front screen. To be provided with no glass or with sanded glass diffuser.

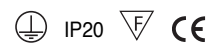
Ausführung in grau lackiertem Metall und vorderer Schirm glanzverchromt. Mit seidenmattem Glas oder ohne.

Окрашенное в серый и хромовый цвета металлическое основание. Поставляется, как со стеклом, обработанным пескоструйным способом, так и без стекла.



	TYPE	ELECTR.	SOCKET	LAMP	CODE	FINISHING
GEA senza vetro (without glass)	GEA-A1	80W	R7s78mm	QT-DE 	T133	23
GEA senza vetro (without glass)	GEA-A2	120W	R7s118mm	QT-DE 	T135	23
GEA con vetro (with glass)	GEA-A1	80W	R7s78mm	QT-DE 	T132	23
GEA con vetro (with glass)	GEA-A2	120W	R7s118mm	QT-DE 	T134	23



23 Cromo
Chrome

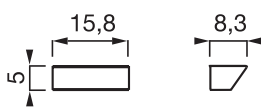

GEA-A1
T133-23

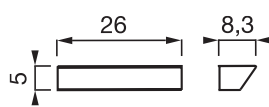

GEA-A2
T135-23

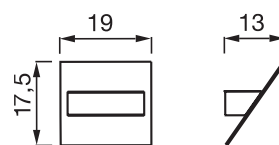

GEA-A1
T132-23

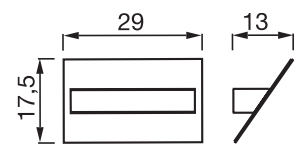

GEA-A2
T134-23



Riflettore frontale in metallo verniciato o cromo spazzolato. Alimentazione elettronica.

Réflecteur frontal en métal disponible dans les versions vernies ou en chrome brossé. Ballast électronique.



Reflector frontal de metal disponible en versión barnizada o cromo cepillado. Ballast electrónico.

Metal reflector available in painted or brushed chrome. Electronic ballast.

Der vordere Metallreflektor ist lackiert oder in gebürstetem Chrom erhältlich. Elektronische Stromversorgung.

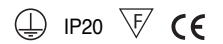
Металлический отражатель представлен в окрашенном сером цвете или в хrome. Электронный балласт.



	TYPE	ELECTR.	SOCKET	LAMP	CODE	FINISHING
PARETE WALL	HOT-A1	80W	R7s78mm	QT-DE 	T125	24 - 28
PARETE WALL	HOT-A2	120W	R7s118mm	QT-DE 	T126	24 - 28
PARETE WALL	HOT-A3	24W	G5	T5 	T127	24 - 28

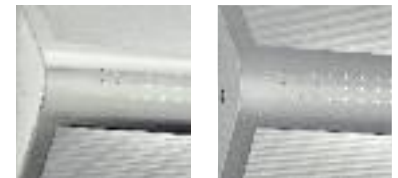

24 Cromo spazzolato
Brushed chrome

28 Grigio-argento
Silver grey

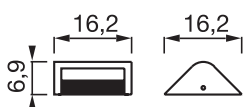

HOT-A1

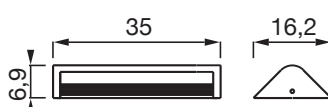

HOT-A2

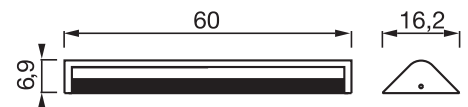

HOT-A3

Hot

Lampada da parete e soffitto. Wall and ceiling lamp.



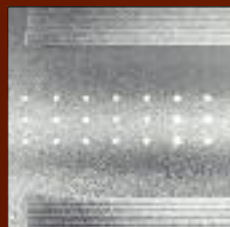
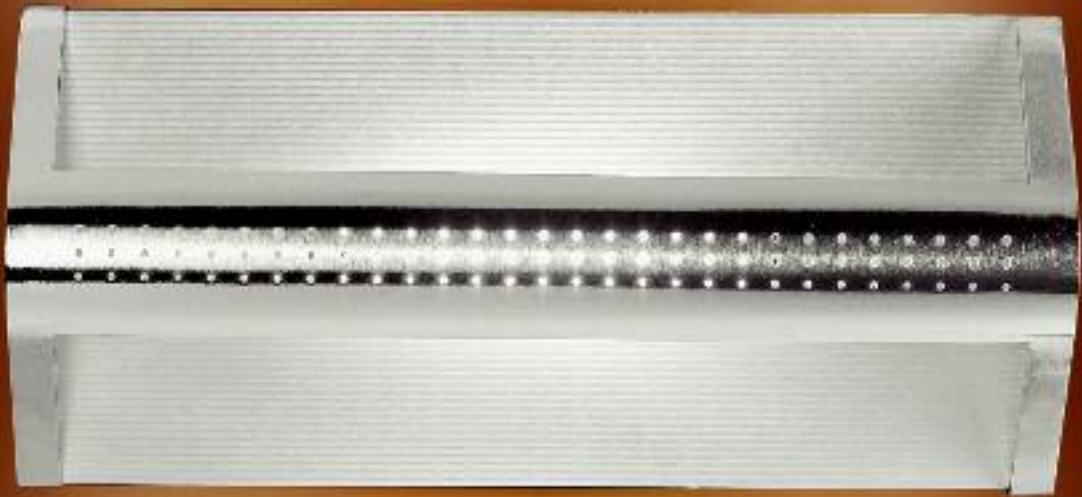



Riflettore frontale orientabile in metallo grigio o cromato. Base in metallo rigato verniciato grigio.

Applique orientable en métal disponible dans la version grise ou chromée brillante. La base de l'applique est en métal rayé verni gris.





Reflector frontal orientable de metal disponible en versión barnizada gris o cromada brillante. La base del aparato es de metal rayado barnizado gris.

Adjustable metal reflector available in the grey painted or glossy chrome versions. The fixture base is in grey painted scored metal.

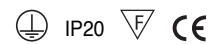
Vorderer Reflektor aus Metall, erhältlich in grau lackierter in glänzend verchromter Version. Der Fuß ist aus grau lackiertem geriffeltem Metall.

Настраиваемый металлический отражатель представлен в окрашенном сером или глянцевом хромированном цветах.



	TYPE	ELECTR.	SOCKET	LAMP	CODE	FINISHING
PARETE WALL	FLUONIGHT-A1	80W	R7s78mm	QT-DE 	T128	23 - 28
PARETE WALL	FLUONIGHT-A2	26W	G24d-3	TC-D 	T129	23 - 28
PARETE WALL	FLUONIGHT-A2	120W	R7s118mm	QT-DE 	T130	23 - 28
PARETE WALL	FLUONIGHT-A3	36W	2G11	TC-L 	T131	23 - 28



23 Cromo
Chrome



28 Grigio-
argento
Silver grey

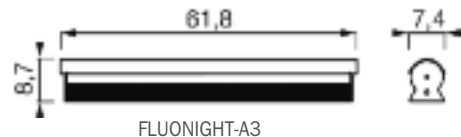
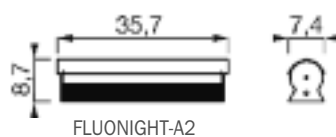

Fluonight

Lampada da parete. Wall lamp.

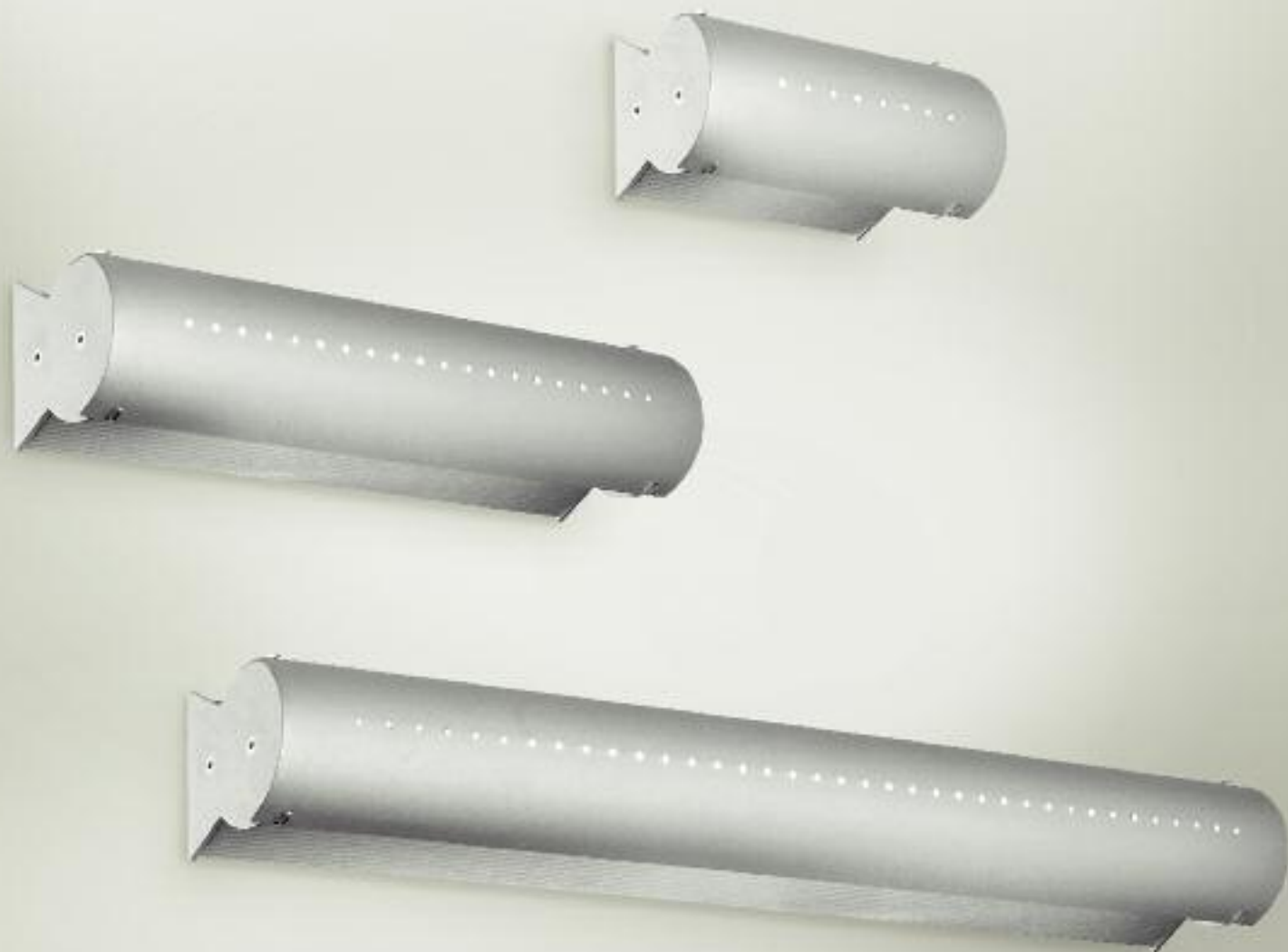





Supporto in metallo rigato verniciato grigio e diffusori in vetro satinato.

Support en métal rayé verni gris et diffuseurs en verre satiné.

Soporte de metal rayado barnizado gris y difusores de vidrio satinado.

Grey painted scored metal structure. Satin glass diffuser.

Grau lackierten Metallhalterung und Reflektoren aus seidenmattem Glas.

Окрашенное в серый цвет шероховатое металлическое основание. Матовое стекло.



		TYPE	ELECTR.	SOCKET	LAMP	CODE	FINISHING
PARETE	WALL	DOMINO-A1	48W	G9	QT-13	T136	28
PARETE	WALL	DOMINO-A2	2x48W	G9	QT-13	T137	28
PARETE	WALL	DOMINO-A3	3x48W	G9	QT-13	T138	28
PARETE	WALL	DOMINO-A4	70W	E27	A55	T139	28
PARETE	WALL	DOMINO-A4	24W	2G11	TC-L	T140	28



28 Grigio-argento
Silver grey

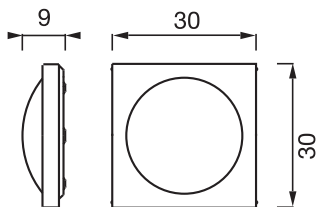

DOMINO-A4

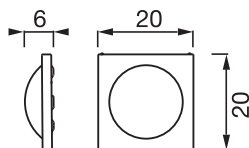

DOMINO-A1

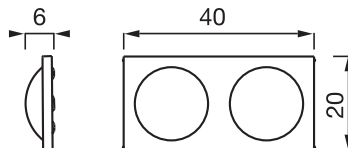

DOMINO-A2

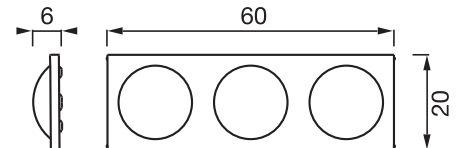

DOMINO-A3

Domino

Lampada da parete e soffitto. Wall and ceiling lamp.

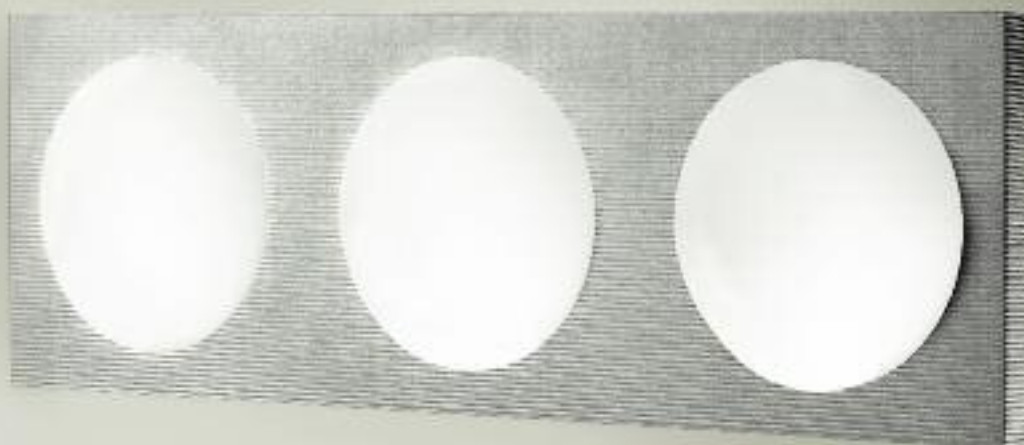
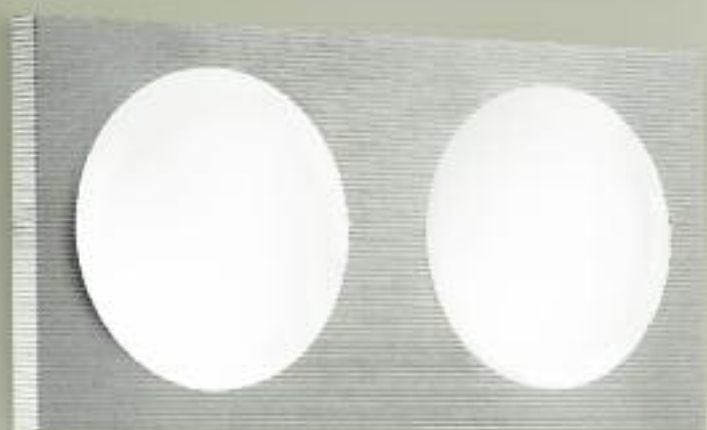

Lampada da parete e soffitto. Wall and ceiling lamp.

Domino

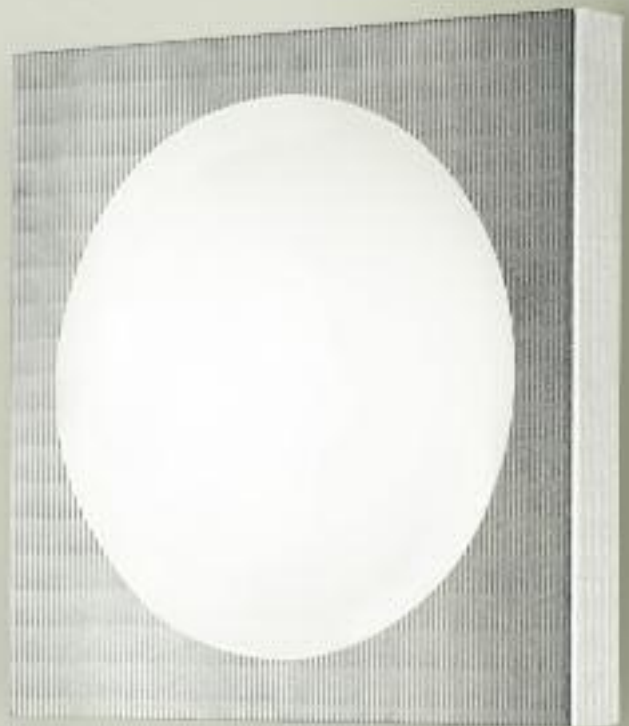
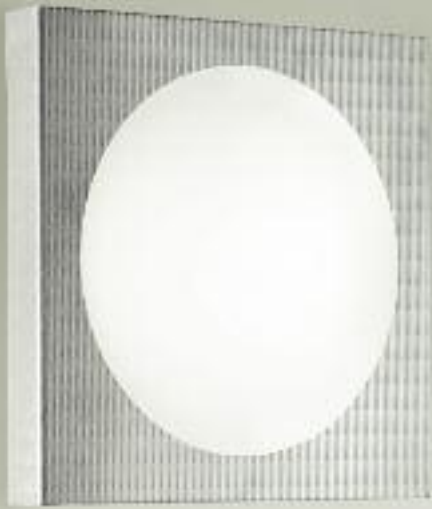



Lampada da parete in metallo verniciato e diffusore in vetro curvato bianco. Disponibile anche con gruppo di emergenza autonomo 1H. Alimentazione elettronica.

Applique en métal verni, diffuseur en verre satin blanc. Disponible aussi avec groupe d'urgence autonome 1H. Ballast électronique.



Lámpara de pared. Estructura metálica barnizada. Difusores en vidrio blanco. Disponible también como lámpara de seguridad con autonomía de 1h. Ballast electrónico.

Wall lamp. Painted metal structure, white satin glass. Available with 1H emergency pack. Electronic ballast.

Metall -Wandleuchte lackiert und Diffusor mit weissem Glas. Auch mit Notlichteinrichtung mit 1H Akkupack erhältlich. Elektronische Stromversorgung.

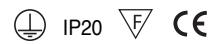
Бра. Крашеное металлическое основание, белое матовое стекло. Есть вариант с аварийным освещением на 1 час. Электронный балласт.



	TYPE	ELECTR.	SOCKET	LAMP	CODE	FINISHING
PARETE WALL	ARGO-A	24W	2G11	TCL 	T257	16
PARETE WALL	ARGO-A	24W	2G11	TCL emergency 1h 	T258	16



16 Bianco
White

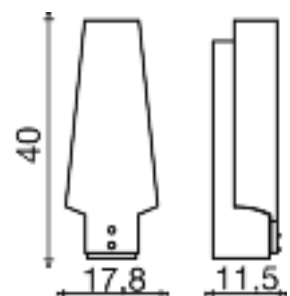

Argo

Lampada da parete. Wall lamp.



Lampada da parete. Wall lamp.

Argo





Struttura in metallo verniciato. Diffusore in vetro bianco, ambra, rosso e nero.

Structure en métal verni. Diffuseur en verre coloré et satiné: blanc, ambre, rouge et noir.





Estructura en metal lacado. Difusor en vidrio blanco, ámbar, rojo y negro.

Painted metal structure. Glass diffuser available in white, amber, red and black.

Struktur aus lackiertem Metall. Streukörper aus mattem, farbigem Glas weiss, bernsteinfarben, rot und schwarz erhältlich.

Окрашенное металлическое основание. Рассеиватель из стекла представлен в белом, песочном или черном цветах.



	TYPE	ELECTR.	SOCKET	LAMP	CODE	FINISHING
PARETE WALL	BRIGHT-A1	80W	R7s78mm	QT-DE 	T179	16 - 01 - 14 - 15
PARETE WALL	BRIGHT-A2	120W	R7s118mm	QT-DE 	T180	16 - 01 - 14 - 15
PARETE WALL	BRIGHT-A2	26W	G24d-3	TC-D 	T181	16 - 01 - 14 - 15
PARETE WALL	BRIGHT-A3	36W	2G11	TCL 	T182	16 - 01 - 14 - 15

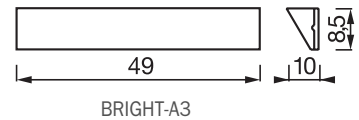
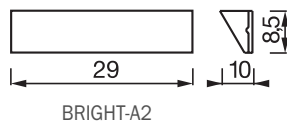
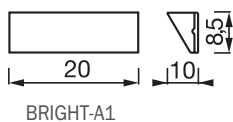
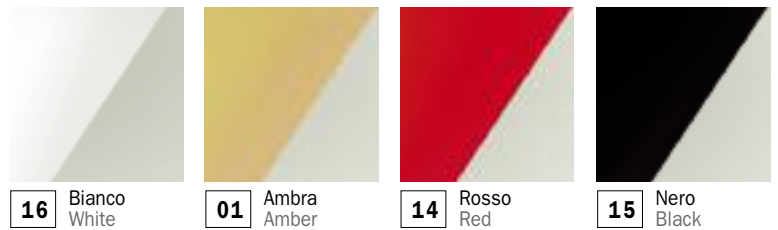

Bright

Lampada da parete. Wall lamp.







Struttura in metallo verniciato. Diffusore in vetro colore ambra con finiture in bianco satinato. Diffusore in vetro colore bianco con finiture a scelta nei colori bianco, rosso e blu.

Structure en métal verni. Verre coloré ambre avec des finissages blancs satinés. Verre blanc avec des finissages dans les couleurs blanc, rouge et bleu au choix.

Estructura de metal lacado. Vidrio de color ámbar con acabados en blanco satinado. Vidrio blanco con acabados de color blanco, rojo o azul.

Painted metal structure. Amber coloured glass diffuser with satinéd white finishing. White glass diffuser to be selected with satinéd white, red and blue finishing.

Struktur aus lackiertem Metall. Streukörper aus bernsteinfarbenem Glas mit Feinbearbeitung in matten weiss. Streukörper aus weissem Glas mit Feinbearbeitung in weiss, rot und blau.

Окрашенное металлическое основание. Рассеиватель из стекла. Электронный балласт в люминесцентной версии. Рассеиватель из стекла. Электронный балласт в люминесцентной версии.

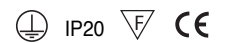

Vetro ambra e finiture in bianco
Amber glass and white details

	TYPE	ELECTR.	SOCKET	LAMP	CODE	FINISHING
PARETE WALL	GAIA-A1	80W	R7s78mm	QT-DE	T183	16
PARETE WALL	GAIA-A1	18W	G24d-2	TC-D	T184	16
PARETE WALL	GAIA-A2	24W	2G11	TCL	T185	16
PARETE WALL	GAIA-A3	36W	2G11	TCL	T186	16

Vetro bianco e finiture colorate
White glass and coloured details

PARETE WALL	GAIA-A1	80W	R7s78mm	QT-DE	T187	14 - 16 - 43
PARETE WALL	GAIA-A1	18W	G24d-2	TC-D	T188	14 - 16 - 43
PARETE WALL	GAIA-A2	24W	2G11	TCL	T189	14 - 16 - 43
PARETE WALL	GAIA-A3	36W	2G11	TCL	T190	14 - 16 - 43



Vetro bianco
White glass

Vetro ambra
Amber glass



14 Rosso
Red

16 Bianco
White

43 Blu
Blue

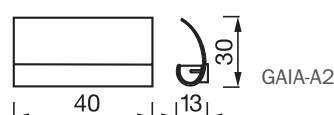
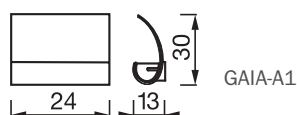

Gaia

Lampada da parete. Wall lamp.







Struttura in metallo verniciato. Diffusore in vetro satinato nei colori ambra e bianco.

Structure en métal. Diffuseur en verre satiné dans les couleurs: opale et ambre.

Estructura en metal. Diffusor en vidrio satinado ámbra y opal.

Painted metal plate. Satin glass available in amber and white.

Armatur aus lackiertem Metall. Glass seidenmatt Opal oder Bernstein.

Металлическое окрашенное крепление. Матовое стекло песочного или белого цвета.

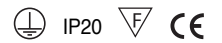

	TYPE	ELECTR.	SOCKET	LAMP	CODE	FINISHING
PARETE WALL	KLYPTA-A	70W	E27	A55	T151	01 - 16



01 Ambra
Amber

16 Bianco
White

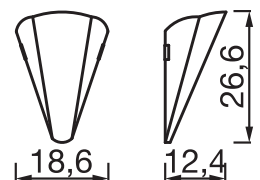



**Diffusori in vetro satinato.
Supporto in metallo
cromato.**

Diffuseurs en verre satiné.
Support en métal laqué.



Difusores en vidrio
satinado. Soporte de
metal cromado.

Satin glass diffuser.
Chrome metal structure.

Reflektoren aus
seidenmattem Glas.
Halterung aus
verchromtem Metall.

Матовый рассеиватель из
стекла Окрашенное
металлическое основание.

⊥ IP40 ⚡ CE

	TYPE	ELECTR.	SOCKET	LAMP	CODE	FINISHING
PARETE WALL	JOLE-A	42W	E14	P45 	T110	23
PARETE WALL	JOLE-A	80W	R7s78mm	QT-DE 	T111	23



23 Cromo
Chrome

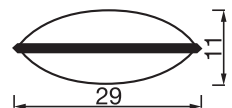



**Struttura in termoplastico.
Diffusore in vetro satinato.**

Support en thermoplastique,
diffuseur en verre satiné.

Estructura termoplástica. Vidrio satinado.

Thermoplastic structure.
Satin glass diffuser.

Armatur aus Thermoplast, Glas seidenmatt.

Рассеиватель из матового стекла.

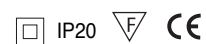

	TYPE	ELECTR.	SOCKET	LAMP	CODE	FINISHING
PARETE WALL	SAIL	52W	E27	A55	P025	16
PARETE WALL	SAIL	18W	G24d-2	TC-D	P238	16
PARETE WALL	NUVOLA	52W	E27	A55	P023	12 - 16 - 43
PARETE WALL	NUVOLA	18W	G24d-2	TC-D	P237	12 - 16 - 43
PARETE WALL	SAMURAI	52W	E27	A55	P026	16
PARETE WALL	SAMURAI	18W	G24d-2	TC-D	P239	16

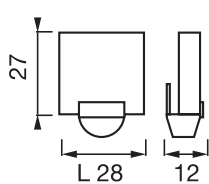

SAIL

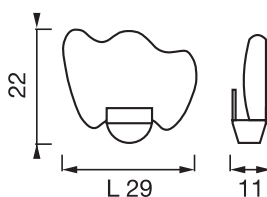

NUVOLA

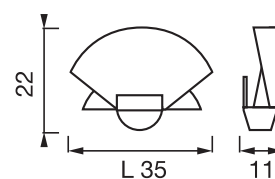

SAMURAI

Nuvola

Lampada da parete. Wall lamp.



Lampada da parete. Wall lamp.

Sail_Samurai



Sail



Samurai

Supporto in termoplastico, reggivetri cromati o ottonati. Diffusore in vetro satinato.



Thermoplastic structure, chromed or brass-plated glass holders. Satin glass diffuser.



Support en thermoplastique, supports verre chromes ou laitonnés, diffuseur en verre satiné.

Armatur aus Thermoplast, Glashalter verchromt oder mit Messingbeschichtung. Glas seidenmatt.

Soporte termoplástico, soportes del vidrio cromados o bronceados. Vidrio satinado.

Рассеиватель из матового стекла.

IP40  

	TYPE	ELECTR.	SOCKET	LAMP	CODE	FINISHING
PARETE WALL	LUNA-2	28W	E14	P45 	P081	22 - 23
PARETE WALL	LUNA-3	42W	E27	A55 	P082	22 - 23



22 Ottone
Brass



23 Cromo
Chrome

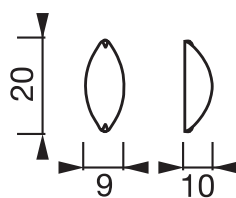

LUNA-2

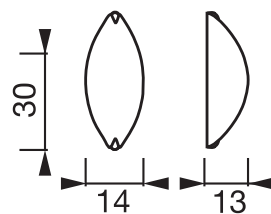

LUNA-3

Supporto in metallo verniciato. Diffusore in vetro satinato.

Support en métal laqué, diffuseur en verre satiné.

Soporte de metal barnizado. Vidrio satinado.

Painted metal structure.
Satin glass diffuser.

Armatur aus lackiertem Metall, Glas seidenmatt.

Рассеиватель из матового стекла.

⊕ IP20 ⚡ CE

	TYPE	ELECTR.	SOCKET	LAMP	CODE	FINISHING
PARETE WALL	STADIUM	42W	E27	A55 	P013	16



16 Bianco
White

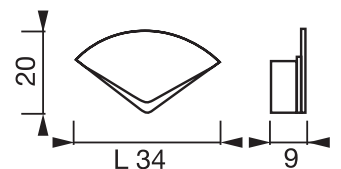

STADIUM



Base e riflettore in metallo verniciato, stelo in metallo cromato.

Base et réflecteur en métal laqué, tige en métal chromé.



Base y reflector de metal barnizado, palo de metal cromado.

Painted metal base and reflector, chrome stem.

Fuß und Reflektor aus lackiertem Metall, Ständer aus verchromtem Metall.

Окрашенное металлическое основание и отражатель Хромовая ножка.

IP20  

	TYPE	ELECTR.	SOCKET	LAMP	CODE	FINISHING
TAVOLO TABLE	TAIA-TA	42W	E14	P45 	T283	15 - 28
TERRA FLOOR	TAIA-TE	42W	E14	P45 	T284	15 - 28

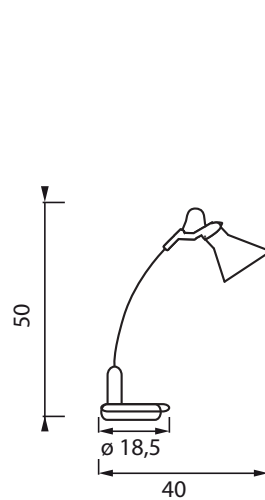
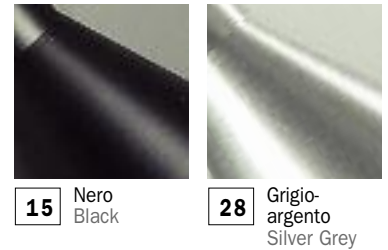

TAIA-TA

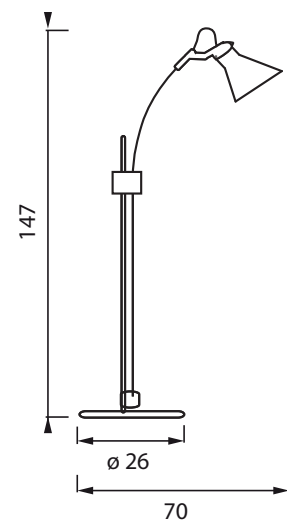

TAIA-TE

Taia

Lampada da terra. Floor lamp.







Base e riflettore in metallo verniciato, stelo in metallo cromato.

Base et réflecteur en métal laqué, tige en métal chromé.

Base y reflector de metal barnizado, palo de metal cromado.

Painted metal base and reflector, chrome stem.

Fuß und Reflektor aus lackiertem Metall, Ständer aus verchromtem Metall.

Окрашенное металлическое основание и отражатель
Хромовая ножка.

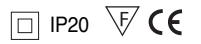

	TYPE	ELECTR.	SOCKET	LAMP	CODE	FINISHING
TAVOLO TABLE	RANDA-TA	42W	E14	P45	P095	15 - 28
TERRA FLOOR	RANDA-TE	42W	E14	P45	P096	15 - 28



15 Nero
Black



28 Grigio-argento
Silver Grey

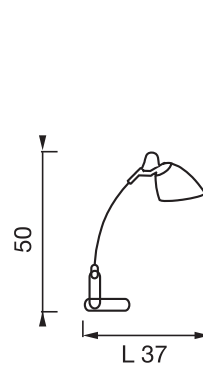

RANDA-TA

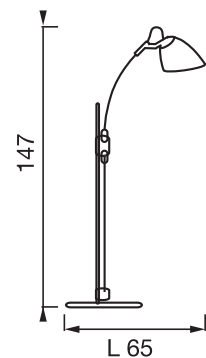

RANDA-TE

Base in metallo cromato e verniciato. Diffusore in vetro soffiato satinato.



Chrome plated and painted metal base. Satin blown glass diffuser.

Diffuseur en verre soufflé satiné. Base en métal chromé et laqué.

Gebblasenem Glas, Basis aus verchromtem und lackiertem Metall.

Base de metal cromado y barnizado. Vidrio soplado y satinado.

Металлическое основание. Рассеиватель из дутого матового стекла.

IP20  

TAVOLO TABLE

TYPE	ELECTR.	SOCKET	LAMP	CODE	FINISHING
ISOTTA	28W	E14	P45 	P085	16 - 43



16 Bianco
White



43 Blu
Blue

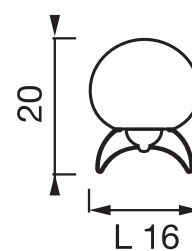



Technical and bathroom light >>>



Struttura in acciaio inox AISI 304. Diffusore in vetro masterpoint. Fissaggio dell'anello a baionetta. Grado di protezione IP 54. Anche per installazioni esterne.

Structure métallique inox steel AISI 304. Verre master point. Fixation de la bague à baïonnette. IP 54. Indiqué aussi pour installations extérieures.

Estructura metálica en acero inox AISI 304. Vidrio masterpoint. Fijaje del anillo a bayoneta. IP 54. Adecuado para instalaciones exteriores.

AISI 304 stainless steel collar. Master point glass. Twist-and-lock fixing. IP 54. Suitable also for outdoor application.

Struktur inox Stahl AISI 304. Masterpoint Glas. IP 54.

Нержавеющая сталь. Стекло. IP 54. И для внешних установок.



	TYPE	ELECTR.	SOCKET	LAMP	CODE	FINISHING
PARETE/SOFFITTO WALL/CEILING	AI-PI-P1	33W	G9	QT13	T148	25
PARETE/SOFFITTO WALL/CEILING	AI-PI-P3	42W	E27	A55	T141	25
PARETE/SOFFITTO WALL/CEILING	AI-PI-P3	16W	GR8	TC-DD	T142	25
PARETE/SOFFITTO WALL/CEILING	AI-PI-P3	2x9W	G23	TCS	T143	25
PARETE/SOFFITTO WALL/CEILING	AI-PI-P4	2x42W	E27	A55	T144	25
PARETE/SOFFITTO WALL/CEILING	AI-PI-P4	28W	GR8	TC-DD	T145	25
PARETE/SOFFITTO WALL/CEILING	AI-PI-P4	26W	G24d-3	TC-D	T146	25
PARETE/SOFFITTO WALL/CEILING	AI-PI-P4	1x18W	G24q-2	TC-DE emergency 1h	T192	25



25 Acciaio satinato
Satinated steel

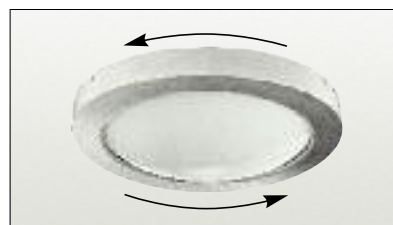

AI-PI-P1

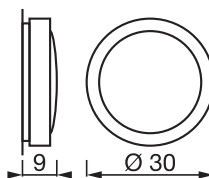

AI-PI-P3

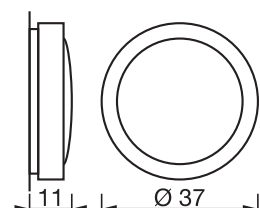

AI-PI-P4



Struttura metallica verniciata o galvanizzata. Diffusore in vetro acidato. Fissaggio dell'anello a baionetta. Grado di protezione IP 54. Solo per installazioni interne.

Structure métallique vernie Verre traité à l'acide. Fixation de la bague à baïonnette. IP 54. Indiqué seulement pour installations intérieures.

Estructura metálica lacada o galvanizada. Vidrio satinado. Fisaje del anillo a bayoneta. IP 54. Adecuado sólo para instalaciones interiores.

Collar available in white and aluminium painted, chrome and brushed nickel. Satin glass. Twist-and-lock fixing. IP 54. Only for indoor installation.

Struktur aus lackiertem oder galvanisiertem Aluminium. Milchglas. Befestigung des Bajonettrings. IP 54.

Нержавеющая сталь. Стекло. IP 54. только для внутренних установок.



	TYPE	ELECTR.	SOCKET	LAMP		CODE	FINISHING
PARETE/SOFFITTO WALL/CEILING	AI-PI-P1	33W	G9	QT-13		T147	16 - 23 - 28 - 34
PARETE/SOFFITTO WALL/CEILING	AI-PI-P3	42W	E27	A55		T070	16 - 23 - 28 - 34
PARETE/SOFFITTO WALL/CEILING	AI-PI-P3	16W	GR8	TCDD		T071	16 - 23 - 28 - 34
PARETE/SOFFITTO WALL/CEILING	AI-PI-P3	2x9W	G23	TCS		T072	16 - 23 - 28 - 34
PARETE/SOFFITTO WALL/CEILING	AI-PI-P4	2x42W	E27	A55		T075	16 - 23 - 28 - 34
PARETE/SOFFITTO WALL/CEILING	AI-PI-P4	28W	GR8	TCDD		T076	16 - 23 - 28 - 34
PARETE/SOFFITTO WALL/CEILING	AI-PI-P4	26W	G24d-3	TCD		T077	16 - 23 - 28 - 34
PARETE/SOFFITTO WALL/CEILING	AI-PI-P4	1x18W	G24q-2	TC-DE emergency 1h		T191	16 - 23 - 28 - 34
PARETE/SOFFITTO WALL/CEILING	AI-PI-P5	3x42W	E27	A55		T231	16 - 28 - 34
PARETE/SOFFITTO WALL/CEILING	AI-PI-P5	40W+22W	2GX13	T5c		T232	16 - 28 - 34
PARETE/SOFFITTO WALL/CEILING	AI-PI-P5	2x24W	2G11	TCL		T233	16 - 28 - 34
PARETE/SOFFITTO WALL/CEILING	AI-PI-P5	2x24W	2G11	TCL emergency 1h		T234	16 - 28 - 34



16 Bianco White



23 Cromo Chrome



28 Grigio-argento Silver grey



34 Nichel spazzolato Brushed nickel

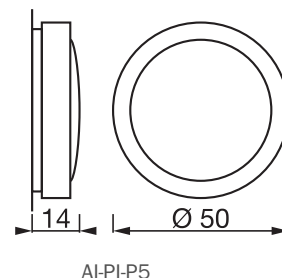
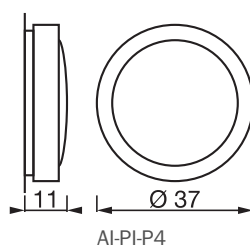
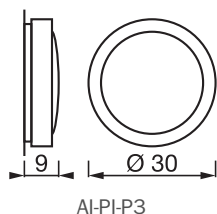
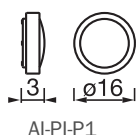
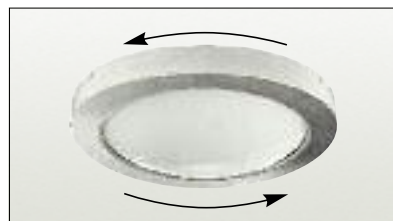

Ai_Pi

Lampada da parete e soffitto. Wall and ceiling lamp.







Struttura in metallo verniciato. Diffusore in vetro soffiato opale satinato. Fissaggio del vetro a baionetta. IP44.

Structure en métal verni gris, verre soufflé satiné opale. Fixation du verre à baïonnette. IP44.







Estructura en metal lacado gris y vidrio soplado opal satinado. Fijaje del vidrio a bayoneta. IP44.

Grey painted metal Structure. Opal satin blown glass. Twist-and-lock fixing. IP44.

Struktur aus Metall mit grauer Lackierung. Satiniertem, geblasenem Opalglas. Befestigung des Glases mit Bajonettverschluß. IP44.

Окрашенное в серый цвет металлическое основание Матовое дутое стекло. IP44.



	TYPE	ELECTR.	SOCKET	LAMP	CODE	FINISHING
PARETE/SOFFITTO WALL/CEILING	EOS-P3	16W	GR8	TC-DD 	T154	28
PARETE/SOFFITTO WALL/CEILING	EOS-P3	2x9W	G23	TC-S 	T155	28
PARETE/SOFFITTO WALL/CEILING	EOS-P3	42W	E27	A55 	T156	28
PARETE/SOFFITTO WALL/CEILING	EOS-P4	28W	GR8	TC-DD 	T157	28
PARETE/SOFFITTO WALL/CEILING	EOS-P4	26W	G24d-3	TC-D 	T158	28
PARETE/SOFFITTO WALL/CEILING	EOS-P4	2x42W	E27	A55 	T159	28



28 Grigio-argento
Silver Grey

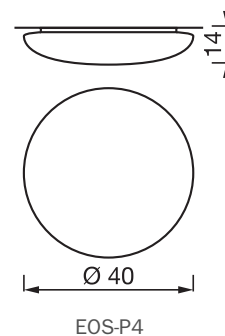
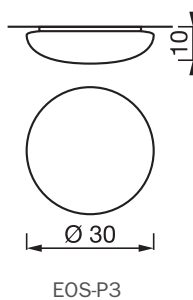



IP54

design Poom Lab

Sq_Easy

Struttura in metallo verniciato, diffusore in vetro stampato satinato. IP54.



Structure en métal laqué, diffuseur en verre satiné. IP54.





Estructura de metal barnizado. Vidrio imprimido satinado. IP54.

Painted metal structure. White satin printed glass. IP54.

Lackiertem Metall, seidenmattes Glas. IP54.

Окрашенное металлическое основание Матовое стекло. IP54.

IP54   

	TYPE	ELECTR.	SOCKET	LAMP	CODE	FINISHING
PARETE/SOFFITTO WALL/CEILING	SQ-EASY-P3	2x42W	E27	A55 	T226	15 - 16 - 28
PARETE/SOFFITTO WALL/CEILING	SQ-EASY-P3	2x18W	2G11	TCL 	T227	15 - 16 - 28
PARETE/SOFFITTO WALL/CEILING	SQ-EASY-P3	28W	GR8	TC-DD 	T229	15 - 16 - 28
PARETE/SOFFITTO WALL/CEILING	SQ-EASY-P3	2x18W	2G11 electronic ballast	TCL 	T235	15 - 16 - 28
PARETE/SOFFITTO WALL/CEILING	SQ-EASY-P3	2x11W	2G7 emergency 1h	TC-SE 	T228	15 - 16 - 28



15 Nero Black



16 Bianco White



28 Grigio-argento Silver Grey

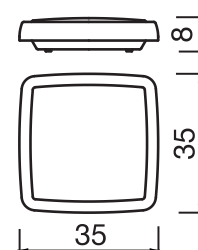

Sq_Easy

Lampada da parete e soffitto. Wall and ceiling lamp.



Lampada da parete e soffitto. Wall and ceiling lamp.

Sq_Easy





Lampade da parete e soffitto. Struttura metallica verniciata bianca, grigia oppure nera. Diffusore in PMMA opale satinato. Grado di protezione IP54 Alimentazione elettronica.

Applique/plafonnière, structure métallique verni, blanc, gris ou noir. Diffuseur en PMMA opale satinée. Degré de protection IP 54. Ballast électronique.



Estructura de metal barnizado blanco, gris o negro. Difusor de PMMA opalino. IP54 Ballast electrónico.

Ceiling and wall lamps. Painted metal frame available in white, grey and black. Opal satin PMMA acrylic diffuser. IP 54 rated. Electronic ballast.

Wand und Deckenleuchte. Struktur in weiss, grau oder schwarz lackiertem Metall. Diffusor in PMMA opal satiniert. Schutzart IP 54. Elektronische Stromversorgung.

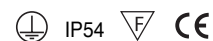
Потолочный светильник - бра. Крашеное металлическое основание белого, серого или черного цветов. Рассеиватель из метакрилата. IP54. Электронный балласт.



	TYPE	ELECTR.	SOCKET	LAMP	CODE	FINISHING
PARETE/SOFFITTO WALL/CEILING	IDROO-P1	21W	E27	TC-TSE 	T267	15 - 16 - 28
PARETE/SOFFITTO WALL/CEILING	IDROO-P1	26W	G24q-3	TC-DE 	T268	15 - 16 - 28
PARETE/SOFFITTO WALL/CEILING	IDROO-P2	2x24W	G5	T5 	T269	15 - 16 - 28



15 Nero
Black



16 Bianco
White



28 Grigio-argento
Silver Grey

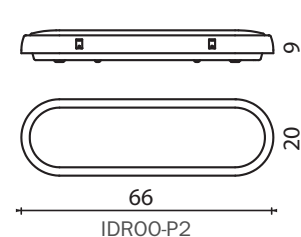
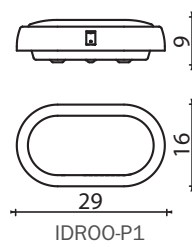

Idroo

Lampada da parete e soffitto. Wall and ceiling lamp.



Lampada da parete e soffitto. Wall and ceiling lamp.

Idroo





Struttura in metallo cromato o nickel spazzolato. Grado di protezione IP44. Solo per installazioni interne.

Structure en métal chromé ou nickel brossé. Degrés de protection IP44. Seulement pour installation intérieures.

Estructura en metal cromo brillo o niquel cepillado. IP44. Adecuado solo para instalaciones interiores.

Metal structure available in chrome and brushed nickel. IP44 rated. Only for indoor installation.

Struktur in verchromtem oder nickel mattem Metall. Schutzart IP44. Nur für Installationen im Innenbereich gedacht.

Металлическое основание в никеле или хrome. IP44. Только для внутреннего использования.



	TYPE	ELECTR.	SOCKET	LAMP	CODE	FINISHING
PARETE WALL	FLOAT-A1	50W	GU10	QPAR	T259	23 - 34
PARETE WALL	FLOAT-A2	2x35W	GU10	QPAR	T260	23 - 34



23 Cromo
Chrome



34 Nichel spazzolato
Brushed nickel

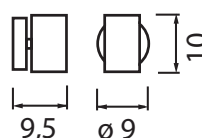

FLOAT-A1

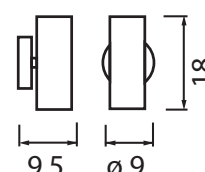

FLOAT-A2



Struttura in metallo cromo o nickel spazzolato. Vetro soffiato pirex. Grado di protezione IP44. Solo per installazioni interne.

Structure en métal chrome brillant ou nickel brossé. Diffuseur en verre soufflé pyrex. IP44. Seulement pour installation intérieure.

Estructura en metal cromo brillo o niquel cepillado. Difusor en vidrio soplado pirex. IP44. Adecuado solo para instalaciones interiores.

Metal structure available in brushed nickel and chrome. Blown glass pyrex diffuser. IP44 rated. Only for indoor installation.

Struktur aus Metall in glänzend verchromt oder Nickel geburstet. Weiss PMMA diffuser. Pirex geblasenem glas. IP 44. Nur für Installationen im Innenbereich gedacht.

Рассеиватель из жаростойкого стекла. Металлическое основание в никеле или хrome. IP 44. только для внутренних установок.

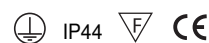

Vetro pirex decoro trasparente
Clear pyrex glass

	TYPE	ELECTR.	SOCKET	LAMP	CODE	FINISHING
PARETE WALL	ONSEN-A1T	17W	E27	TC-TSE	T245	23 - 34
PARETE WALL	ONSEN-A2T	2x17W	E27	TC-TSE	T249	23 - 34

Vetro pirex decoro blu
Blue pyrex glass

PARETE WALL	ONSEN-A1B	17W	E27	TC-TSE	T247	23 - 34
PARETE WALL	ONSEN-A2B	2x17W	E27	TC-TSE	T251	23 - 34



Blu
Blue



Trasparente
Clear



23 Cromo
Chrome



34 Nichel spazzolato
Brushed nickel

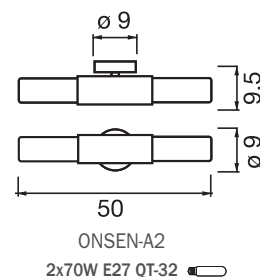
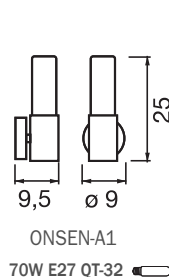



Diffusore in vetro.
Utilizzabile nella versione semplice o con l'applicazione di una cornice in metallo verniciata o galvanizzata.
IP44.

Verre satiné. Disponible dans la version simple ou avec un encadrement en métal verni ou galvanisé. IP44.

Difusor en vidrio. Se puede utilizar en la versión simple o aplicándole un marco de metal pintado o galvanizado. IP44.

Glass difuser. Available as our standard and with collar in aluminium, yellow, orange painted and chrome. IP 44.

Glas seidenmatt. In einfacher Ausführung, oder mit galvanisiertem oder lackiertem Metallrahmen. IP44.

Стеклянный рассеиватель. Кольца представлены в алюминии, желтом, оранжевом или хромированном цветах. IP44.



	TYPE	ELECTR.	SOCKET	LAMP	CODE	FINISHING
PARETE/SOFFITTO WALL/CEILING	OSTER-P3	42W	E27	A55	P220	
PARETE/SOFFITTO WALL/CEILING	OSTER-P3	16W	GR8	TC-DD	P221	
PARETE/SOFFITTO WALL/CEILING	OSTER-P3	2x9W	G23	TC-S	P233	
PARETE/SOFFITTO WALL/CEILING	OSTER-P4	2x42W	E27	A55	P234	
PARETE/SOFFITTO WALL/CEILING	OSTER-P4	28W	GR8	TC-DD	P235	
PARETE/SOFFITTO WALL/CEILING	OSTER-P4	26W	G24d-3	TC-D	P236	

Cornice decorativa in metallo deco FIORI

Optional decorative FLOWER metal frame

FIORI FLOWER	OSTER-P3	Ø30 cm	P217	04 - 12 - 23 - 28
FIORI FLOWER	OSTER-P4	Ø40 cm	P219	04 - 12 - 23 - 28

Cornice decorativa in metallo deco TRIANGOLI

Optional decorative TRIANGLE metal frame

TRIANGOLO TRIANGLE	OSTER-P3	Ø30 cm	P216	04 - 12 - 23 - 28
TRIANGOLO TRIANGLE	OSTER-P4	Ø40 cm	P218	04 - 12 - 23 - 28



Fiori
Flower



Triangoli
Triangle



04 Arancio
Orange



12 Giallo
Yellow



23 Cromo
Chrome



28 Grigio argento
Silver grey

SENZA CORNICE
WITHOUT METAL FRAME

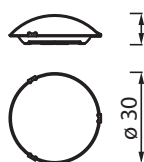

OSTER-P3

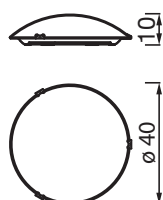

OSTER-P4

CON CORNICE
WITH METAL FRAME

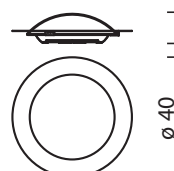

OSTER-P3

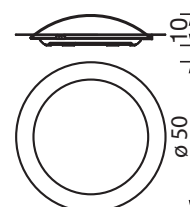

OSTER-P4

Oster

Lampada da parete e soffitto. Wall and ceiling lamp.







Easy light >>>

Hut_BigHut

Sospensione. Pendant lamp.

Riflettore in metallo colorato verniciato.

Painted metal structure.

Monture en métal laqué, diffuseur en métal laqué.

Streulicht und Punktlicht, Armatur aus lackiertem Metall.

Reflector de metal colorado y barnizado.

Металлический плафон.



HUT

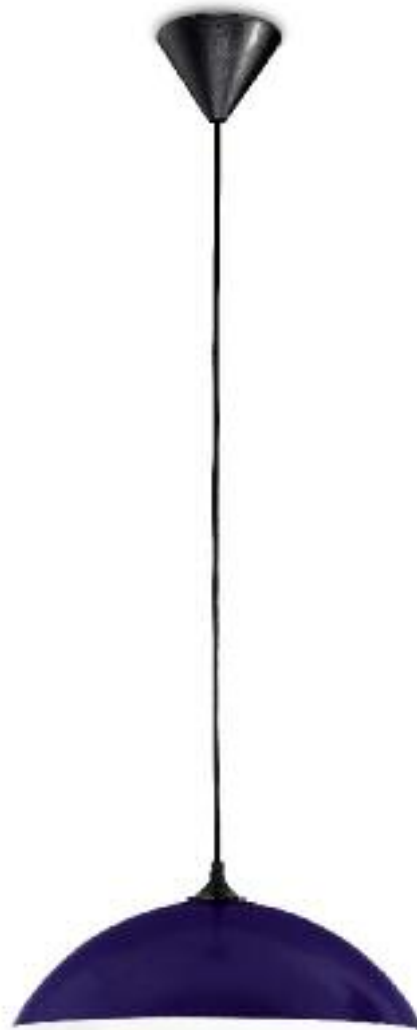

BIG HUT

IP20

	TYPE	ELECTRIFICATION	SOCKET	LAMP	CODE	FINISHING
SOSPENSIONE PENDANT	HUT	52W	E27	A55	P050	14 - 16 - 29 - 43
SOSPENSIONE PENDANT	BIG HUT	70W	E27	A55	P051	14 - 16 - 29 - 43

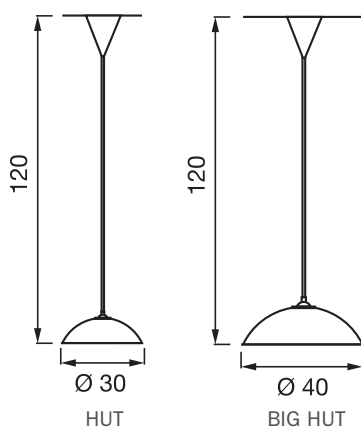

14 Rosso Red



16 Bianco White



29 Alluminio Aluminium



43 Blu Blue

Diecidieci

Lampada da soffitto. Ceiling lamp. / Lampada da parete. Wall lamp.

Struttura metallica verniciata o galvanizzata. Diffusore in vetro satinato.

Collar available in white painted, chrome and brass. Satin glass diffuser.

Structure métallique vernie ou galvanisée. Verre satiné.

Struktur aus lackiertem oder galvanisiertem Metall. Glas seidenmatt.

Estructura metálica lacada o galvanizada. Vidrio satinado.

Кольца представлены в белом цвете, хrome или латуни. Матовое стекло.



⊕ IP20 ⚡ CE

	TYPE	ELECTRIFICATION	SOCKET	LAMP	CODE	FINISHING
SOFFITTO CEILING	DIECI-P3	42W	E27	A55	P010	16 - 22 - 23
SOFFITTO CEILING	DIECI-P3	2x9W	G23	TC-S	P020	16 - 22 - 23
SOFFITTO CEILING	DIECI-P3	16W	GR8	TC-DD	P105	16 - 22 - 23
SOFFITTO CEILING	DIECI-P4	2x42W	E27	A55	P011	16 - 22 - 23
SOFFITTO CEILING	DIECI-P4	28W	GR10q	TC-DDE	P021	16 - 22 - 23
SOFFITTO CEILING	DIECI-P5	2x42W	E27	A55	P261	16 - 22 - 23
SOFFITTO CEILING	DIECI-P5	2x26W electronic ballast	G24q-3	TC-DE	P262	16 - 22 - 23
SOFFITTO CEILING	DIECI-P5	22+40W electronic ballast	2GX13	T5c	P263	16 - 22 - 23
SOFFITTO CEILING	DIECI-P5	38W electronic ballast	GR10q	TC-DDE	P264	16 - 22 - 23
PARETE WALL	DIECI-A	42W	E27	A55	P012	16 - 22 - 23
PARETE WALL	DIECI-A	13W	G24d-1	TC-D	P022	16 - 22 - 23

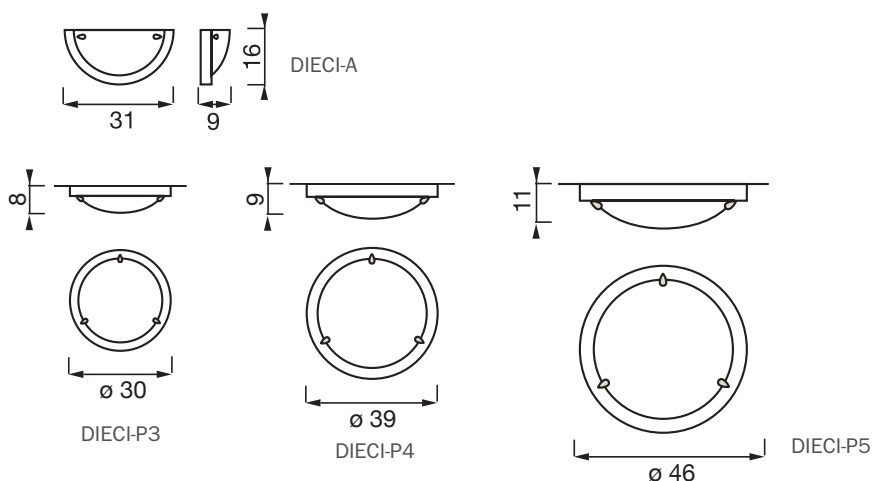

Struttura metallica verniciata. Diffusore in vetro satinato.

Satin glass diffuser.
Chrome glass holders.

Structure métallique vernie. Verre satiné.

Struktur aus lackiertem Metall. Glas seidenmatt.

Estructura metálica lacada. Vidrio satinado.

Рассеиватель из матового стекла Хромовые держатели.



IP20

	TYPE	ELECTRIFICATION	SOCKET	LAMP	CODE	FINISHING
PARETE WALL	KOMET-A	42W	E27	A55	P034	23
SOFFITTO CEILING	KOMET-P3	42W	E27	A55	P035	23
SOFFITTO CEILING	KOMET-P4	2x42W	E27	A55	P002	23



23 Cromo
Chrome

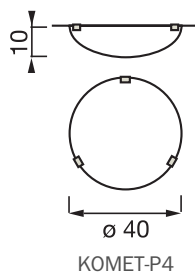
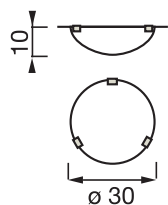
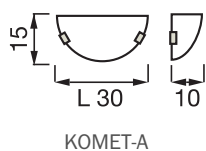

Hook

Lampada da soffitto. Ceiling lamp. / Lampada da parete. Wall lamp.

Reggivetiro in metallo cromato o ottonato. Diffusore in vetro satinato.

Glass holders available in chrome and brass
Satin glass diffuser.

Support laqué, diffuseur en verre satiné.

Lackierte Armatur verchromt oder mit Messingbeschichtung
Fluter aus Glas seidenmatt.

Soporte del vidrio de metal cromado o bronceado. Vidrio satinado.

Хромовые или латунные держатели Рассеиватель из матового стекла.



⊕ IP20 ⚡ CE

	TYPE	ELECTRIFICATION	SOCKET	LAMP		CODE	FINISHING
SOFFITTO CEILING	HOOK-P3	52W	E27	A55		P018	22 - 23
SOFFITTO CEILING	HOOK-P3	22W	G10q	T-R		P231	22 - 23
SOFFITTO CEILING	HOOK-P4	2x42W	E27	A55		P019	22 - 23
SOFFITTO CEILING	HOOK-P4	32W	G10q	T-R		P232	22 - 23
SOFFITTO CEILING	HOOK-P4	2x18W <i>emergency 1h</i>	G24q-2	TC-DE		P249	22 - 23
SOFFITTO CEILING	HOOK-P5	3x42W	E27	A55		P265	22 - 23
SOFFITTO CEILING	HOOK-P5	2x26W <i>electronic ballast</i>	G24q-3	TC-DE		P266	22 - 23
SOFFITTO CEILING	HOOK-P5	22+40W <i>electronic ballast</i>	2GX13	T5c		P267	22 - 23
SOFFITTO CEILING	HOOK-P5	38W <i>electronic ballast</i>	GR10q	TC-DDE		P268	22 - 23
PARETE WALL	HOOK-A	42W	E27	A55		P017	22 - 23

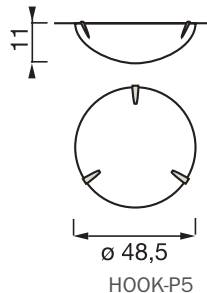
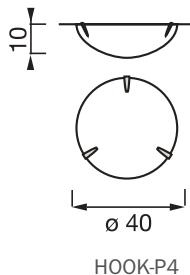
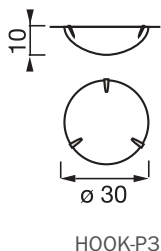
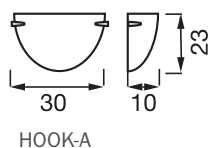

22 Ottone
Brass



23 Cromo
Chrome

Reggivetiro in metallo cromato o ottonato.
Diffusore in vetro satinato.

Glass holders available in chrome and brass.
Satin glass diffuser.

Support laqué, diffuseur en verre satiné.

Lackierte Armatur verchromt oder mit Messingbeschichtung
Fluter aus Glas seidenmatt.

Soporte del vidrio de metal cromado o bronceado. Vidrio satinado.

Хромовые или латунные держатели
Рассеиватель из матового стекла.



⊥ IP20 ⚡ CE

	TYPE	ELECTRIFICATION	SOCKET	LAMP		CODE	FINISHING
SOFFITTO CEILING	POCKET-P3	52W	E27	A55		P015	22 - 23
SOFFITTO CEILING	POCKET-P3	22W	G10q	T-R		P229	22 - 23
SOFFITTO CEILING	POCKET-P4	2x42W	E27	A55		P016	22 - 23
SOFFITTO CEILING	POCKET-P4	32W	G10q	T-R		P230	22 - 23
SOFFITTO CEILING	POCKET-P4	2x18W <i>emergency 1h</i>	G24q-2	TC-DE		P248	22 - 23
SOFFITTO CEILING	POCKET-P5	3x42W	E27	A55		P269	22 - 23
SOFFITTO CEILING	POCKET-P5	2x26W <i>electronic ballast</i>	G24q-3	TC-DE		P270	22 - 23
SOFFITTO CEILING	POCKET-P5	22+40W <i>electronic ballast</i>	2GX13	T5c		P271	22 - 23
SOFFITTO CEILING	POCKET-P5	38W <i>electronic ballast</i>	GR10q	TC-DDE		P272	22 - 23
PARETE WALL	POCKET-A	42W	E27	A55		P014	22 - 23

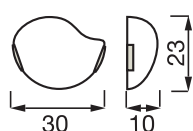

POCKET-A

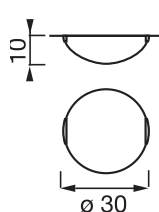

POCKET-P3

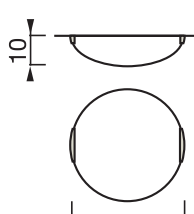

POCKET-P4

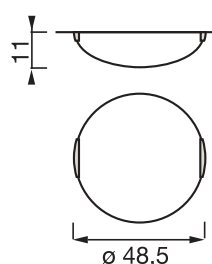

POCKET-P5



22 Ottone
Brass



23 Cromo
Chrome



Struttura in metallo cromato o ottonato o verniciato. Diffusore in vetro serigrafato.

Trim available in chrome, brass and white painted. Screen-printed glass diffuser.

Structure métallique vernie ou galvanisée. Verre satiné sérigraphié.

Struktur aus lackiertem oder galvanisiertem Metall. Glas seidenmatt mit Siebdruck.

Estructura metálica lacada o galvanizada. Vidrio satinado serigrafado.

Кольцо хромового, латунного или белого цвета. Рассеиватель из стекла. Трафаретная печать.

Ring-5 disponibile nella versione in emergenza.

Ring-5 available with emergency kit.



IP20

	TYPE	ELECTRIFICATION	SOCKET	LAMP		CODE	FINISHING
SOFFITTO CEILING	RING-3	42W	E27	A55		P101	16 - 22 - 23
SOFFITTO CEILING	RING-4	2x28W	E27	A55		P102	16 - 22 - 23
SOFFITTO CEILING	RING-4	28W	GR10q	TC-DDE		P103	16 - 22 - 23
SOFFITTO CEILING	RING-4	2x18W	G24d-2	TC-D		P222	16 - 22 - 23
SOFFITTO CEILING	RING-5	2x42W	E27	A55		P257	16 - 22 - 23
SOFFITTO CEILING	RING-5	40W+22W electronic ballast	2GX13	T5c		P258	16 - 22 - 23
SOFFITTO CEILING	RING-5	38W electronic ballast	GR10q	TC-DDE		P259	16 - 22 - 23
SOFFITTO CEILING	RING-5	2x26W electronic ballast	G24q-3	TC-DE		P260	16 - 22 - 23

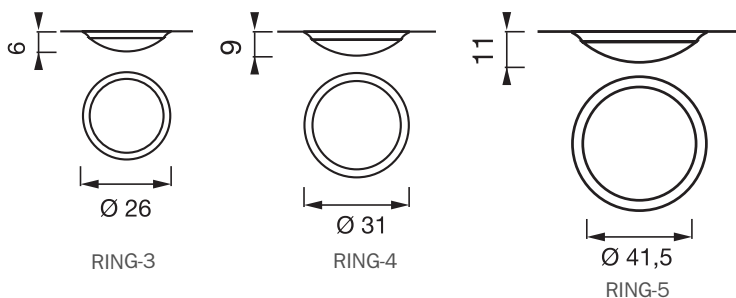

16 Bianco White



22 Ottone Brass



23 Cromo Chrome

Omni

Lampada da parete e soffitto. Wall and ceiling lamp.

Struttura in cromo spazzolato. Diffusore in vetro stampato satinato.

Collar in brushed nickel. Satin glass diffuser.

Structure laqué en chrome brossé, diffuseur en verre satiné.

Metallarmatur mit bürsteten Chrombeschichtung, seidenmattes Glas.

Estructura de cromo cepillado. Vidrio imprimido satinado.

Никель Рассеиватель из матового стекла.



IP20

	TYPE	ELECTRIFICATION	SOCKET	LAMP	CODE	FINISHING
SOFFITTO CEILING	OMNI-P	2x28W	E14	P45	T109	24
SOFFITTO CEILING	OMNI-P	38W	GR10q	TC-DDE	T160	24
SOFFITTO CEILING	OMNI-P	2x18W	G24d-2	TC-D	T161	24

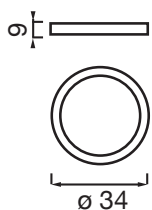

24 Cromo spazzolato
Brushed chrome

Struttura in metallo cromato o ottonato o verniciato. Diffusore in vetro alabastro. Diffusore satinato nella versione in fluorescenza.

Trim available in chrome, brass and white painted. Alabaster glass diffuser. Satin glass diffuser on the fluorescent version.



Structure métallique vernie ou galvanisé. Verre alabâtre. Verre satiné dans la version fluorescente.





Struktur aus lackiertem oder galvanisiertem Metall. Glas seidenmatt Alabaster.

Estructura metálica lacada o galvanizada. Vidrio de alabastro. Vidrio satinado en la versión con fluorescencia.

Кольцо хромового, латунного или белого цвета Алебастр.



IP20  

	TYPE	ELECTRIFICATION	SOCKET	LAMP	CODE	FINISHING
SOFFITTO CEILING	GALASSIA-3	52W	E27	A55 	P099	22 - 23 - 29
SOFFITTO CEILING	GALASSIA-4	2x42W	E27	A55 	P100	22 - 23 - 29
SOFFITTO CEILING	GALASSIA-4	28W	GR10q	TC-DDE 	P223	22 - 23 - 29
SOFFITTO CEILING	GALASSIA-4	2x26W	G24d-3	TC-D 	P224	22 - 23 - 29

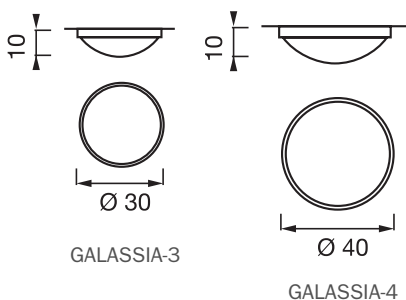

Video

Lampada da parete e soffitto. Wall and ceiling lamp.

Struttura in metallo verniciato. Diffusore in vetro satinato o in PMMA.

Painted metal collar
Diffuser available in
glass and PMMA.

Structure en métal
laqué. Diffuseur en
verre satiné ou PMMA
diffuseur.







Armatur au lackiertem
Metall, Glas
seidenmatt oder aus
PMMA.

Estructura en metal
lacado barnizado.
Difusor en vidrio
satinado o PMMA.

Окрашенный металл
Рассеиватель из стекла или
полиметилметакрилата.



IP20 F CE

	TYPE	ELECTRIFICATION	SOCKET	LAMP	CODE	FINISHING
SOFFITTO CEILING	VIDEO-3	2x42W	E27	A55 	P115	16 - 28
SOFFITTO CEILING	VIDEO-3	28W	GR10q	TC-DDE 	P093	16 - 28
SOFFITTO CEILING	VIDEO-3	2x18W	G24d-2	TC-D 	P240	16 - 28
SOFFITTO CEILING	VIDEO-4	2x52W	E27	A55 	P116	16 - 28
SOFFITTO CEILING	VIDEO-4	38W	GR10q	TC-DDE 	P094	16 - 28
SOFFITTO CEILING	VIDEO-4	2x26W	G24d-3	TC-D 	P241	16 - 28
SOFFITTO CEILING	VIDEO-4	2x18W <i>emergency 1h</i>	G24q-2	TC-DE 	P253	16 - 28

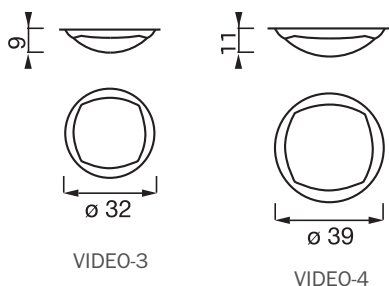

Struttura in metallo cromato opaco.
Diffusore in vetro decorato satinato.

Mat chrome metal collar. Satin glass diffuser.

Structure en métal chromé ou laitonné mat, diffuseur en verre décoré satiné.

Metallarmatur verchromt oder mit Messingbeschichtung, matt, gefärbtes Glas seidenmatt.

Estructura de metal cromado opaco. Vidrio con decorado satinado.

Хромированный металл
Матовое стекло.



⊥ IP20 ⚡ CE

	TYPE	ELECTRIFICATION	SOCKET	LAMP	CODE	FINISHING
SOFFITTO CEILING	MIZAR-3	52W	E27	A55	P086	01 - 16 - 43
SOFFITTO CEILING	MIZAR-4	2x42W	E27	A55	P087	01 - 16 - 43

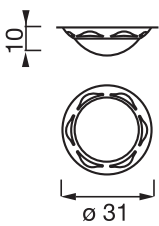

MIZAR-3

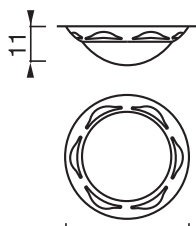

MIZAR-4



01 Ambra
Amber



16 Bianco
White



43 Blu
Blue

Bracket

Lampada da parete. Wall lamp.

Reggivetri cromati e diffusore in vetro colorato satinato.

Metal back plate.
Satin glass diffuser.



Supports chromée,
diffuseur en verre satiné.

Armatur aus Metall,
satiniertem Glass.

Soportes del vidrio cromados y vidrio colorado satinado.

Рассеиватель из матового стекла.



IP20  

PARETE WALL

TYPE	ELECTRIFICATION	SOCKET	LAMP	CODE	FINISHING
BRAKET	28W	E14	P45 	P032	01 - 16

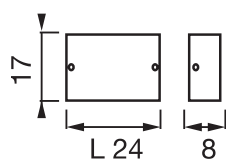

01 Ambra
Amber



16 Bianco
White

QUADRA

Struttura in metallo, reggivetri cromati o ottonati. Diffusore in vetro serigrafato satinato.

Metal back plate.
Satin silk-screened glass diffuser.
Chrome and brass glass holders

Métal laqué, supports verre chromés ou laitonnés, diffuseur en verre sérigraphié satiné.

Armatur aus lackiertem Metall, Glashalter mit Chrom – oder Messingbeschichtung, Glas seidenmatt, Siebdruck-Dekor.

Estructura en metal, soportes del vidrio cromados o bronceados. Vidrio serigrafado satinado.

Металлическое основание
Рассеиватель из стекла.
Трафаретная печать.
Держатели в хроме или латунного цвета

SORRISO

Supporto in metallo e reggivetri in pressofusione nichelato o ottonato opaco. Diffusore in vetro satinato.

Metal back plate.
Satin glass diffuser.
Mat chrome and brass glass holders

Support en métal laqué, supports verre en moulage sous pression nickelé ou laitonné mat, diffuseur en verre satiné.

Armatur aus lackiertem Metall, Glashalter aus Spritzguss mit Nickel – oder Messingbeschichtung matt, Glas seidenmatt.

Soporte de metal barnizado y soportes del vidrio vaciados a presión niquelados o bronceados opacos. Vidrio satinado.

Металлическое основание
Рассеиватель из матового стекла.
Держатели в хроме или латунного цвета



Quadra



Sorriso

⊕ IP20 ⚡ CE

	TYPE	ELECTRIFICATION	SOCKET	LAMP	CODE	FINISHING
SOFFITTO CEILING	QUADRA	52W	E27	A55	P090	22 - 23
SOFFITTO CEILING	SORRISO-3	52W	E27	A55	P108	22 - 27
SOFFITTO CEILING	SORRISO-4	2x42W	E27	A55	P109	22 - 27

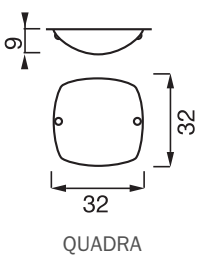

QUADRA

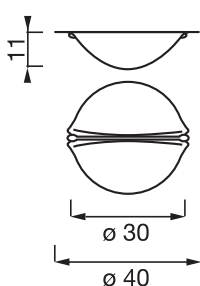

SORRISO-3

SORRISO-4



22 Ottone
Brass



23 Cromo
Chrome



22 Ottone
Brass



27 Nickel opaco
Mat Nickel

Saturno

Lampada da parete e soffitto. Wall and ceiling lamp.

Struttura in metallo verniciato, filtri colorati intercambiabili.
Diffusore in vetro satinato.

Painted metal collar.
 Coloured filters.
 Satin glass diffuser.

Structure en métal laqué, filtres colorés interchangeables, diffuseur en verre satiné.

Armatur aus lackiertem Metall, Austauschbare Farbfilter, Glas seidenmatt.

Estructura de metal barnizado, filtros colorados intercambiables. Vidrio satinado.

Окрашенный металл. Цветные фильтры. Матовое стекло.



⊥ IP20 F CE

SOFFITTO CEILING

TYPE	ELECTRIFICATION	SOCKET	LAMP	CODE	FINISHING
SATURNO	52W	E27	A55	P098	28

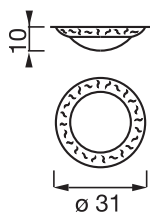

28 Grigio-argento
 Silver grey

Lampada da soffitto e parete. Ceiling and wall lamp.

Dama_Triangoli

Struttura in metallo verniciato, diffusore in vetro serigrafato satinato.

Metal back plate.
Screen-printed glass
diffuser.

Structure en métal
laqué, diffuseur en
verre satiné sérigraphié.

Armaturo aus
lackiertem Metall,
Glass seidenmatt.

Estructura de metal
barnizado, vidrio
serografiado satinado.

Металлическое основание
Рассеиватель из стекла.
Трафаретная печать.



Dama



Triangoli

⊥ IP20 ⚡ CE

	TYPE	ELECTRIFICATION	SOCKET	LAMP	CODE	FINISHING
SOFFITTO CEILING	DAMA	42W	E27	A55	P045	16
SOFFITTO CEILING	TRIANGOLI	42W	E27	A55	P046	16

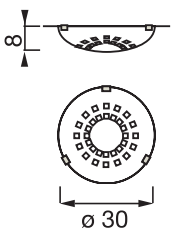

DAMA

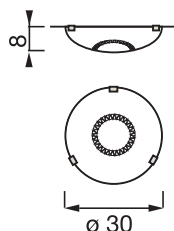

TRIANGOLI



16 Bianco
White

frac_Irish

Lampada da soffitto e parete. Ceiling and wall lamp.

FRAC

Supporto in metallo verniciato e finali in vetro colorato. Diffusore in vetro satinato.

Painted metal back plate. Coloured glass details. Satin glass diffuser.

Support en métal laqué, supports verre en verre coloré, diffuseur en verre satiné.

Armaturo aus lackiertem Metall, Glashalter aus gefärbtem Glas. Glas seidenmatt.

Soporte de metal barnizado y terminaciones de vidrio colorado. Vidrio satinado.

Металлическое основание. Детали из цветного стекла. Рассеиватель из матового стекла.

IRISH

Struttura in metallo brunito. Diffusore in vetro decorato scavo.

Burnished metal structure. "Scavo" glass diffuser.

Support et cadre en métal laqué, diffuseur en verre décoré "scavo".

Armaturo und Rahmen aus lackiertem Metall, Glas mit Scavo-Dekor.

Estructura de metal bruñido. Vidrio condecorado cavado.

Металлическое основание. Рассеиватель из стекла.



Frac



Irish

⊥ IP20 ⚡ CE

	TYPE	ELECTRIFICATION	SOCKET	LAMP	CODE	FINISHING
SOFFITTO CEILING	FRAC-3	28W	E14	P45	P065	05-10-17-18
SOFFITTO CEILING	FRAC-4	42W	E27	A55	P066	05-10-17-18
SOFFITTO CEILING	FRAC-5	2x42W	E27	A55	P067	05-10-17-18
SOFFITTO CEILING	IRISH	52W	E27	A55	P053	39

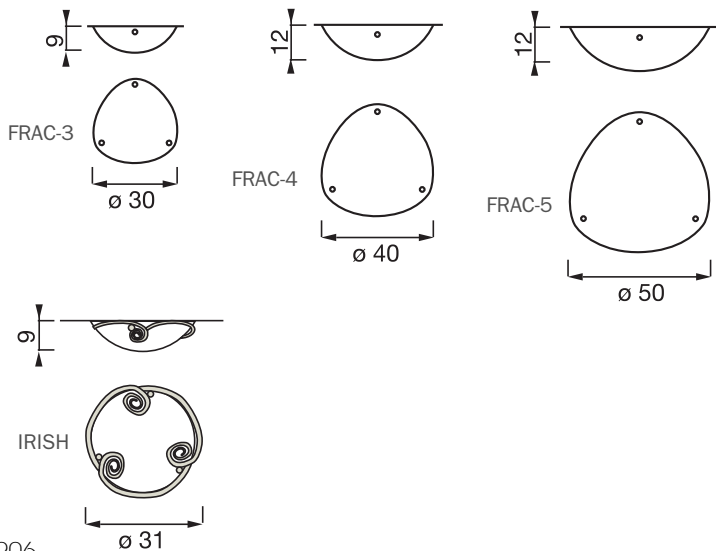

39 Brunito
Antique bronze

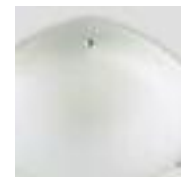

05 Cristallo satinato
Satin crystal



10 Azzurro
Light blue



17 Verde
Green



18 Rosa
Pink

Lampada da soffitto e parete. Ceiling and wall lamp.

Geo_Moon

Struttura in metallo verniciato. Diffusore in vetro satinato.

Painted metal collar.
Satin glass diffuser.

Structure en métal laqué, diffuseur en verre satiné.

Armaturo aus lackiertem Metall, Glas seidenmatt.

Estructura de metal barnizado. Vidrio satinado.

Окрашенный металл
Рассеиватель из матового стекла.



Geo



Moon

⊥ IP20 ⚡ CE

	TYPE	ELECTRIFICATION	SOCKET	LAMP	CODE	FINISHING
SOFFITTO CEILING	GEO	42W	E27	A55	P007	16 - 28 - 43
SOFFITTO CEILING	MOON	42W	E27	A55	P008	16 - 28

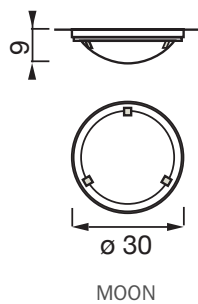
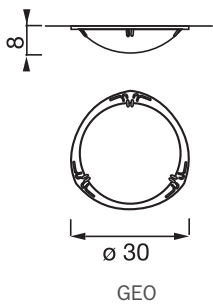

16 Bianco
White



28 Grigio-argento
Silver grey



43 Blu
Blue



16 Bianco
White



28 Grigio-argento
Silver grey

Break - Diabola

Lampada da soffitto e parete. Ceiling and wall lamp.

BREAK

Struttura in metallo verniciato. Diffusore in vetro satinato. IP30

Painted metal collar. Satin glass diffuser. IP30.

Structure en métal laqué, diffuseur en verre satiné. IP30

Armaturo aus lackiertem Metall, Glas seidenmatt. IP30

Estructura de metal barnizado. Vidrio satinado. IP30

Окрашенный металл. Рассеиватель из матового стекла. IP30

DIABOLA

Struttura in metallo verniciato, reggivetro in pressofusione cromati o ottonati, diffusore in vetro satinato. IP20

Satin glass diffuser. Chrome and brass glass holders. IP20.

Structure en métal laqué, supports verre en moulage sous pression chromés ou laitonnés, diffuseur en verre satiné. IP20

Armaturo aus lackiertem Metall, Glashalter aus Spritzguss, verchromt oder mit Messingbeschichtung, Glas seidenmatt. IP20

Estructura de metal barnizado, soportes del vidrio vaciado a presión cromado o bronceado, vidrio satinado. IP20

Держатели в хроме или латунного цвета. IP20



Diabola



Break



	TYPE	ELECTRIFICATION	SOCKET	LAMP	CODE	FINISHING
SOFFITTO CEILING	BREAK	42W	E27	A55	P009	16 - 28
SOFFITTO CEILING	DIABOLA-4	2x42W	E27	A55	P040	22 - 23
SOFFITTO CEILING	DIABOLA-5	2x52W	E27	A55	P041	22 - 23

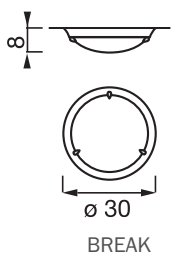

BREAK

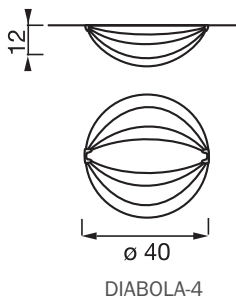

DIABOLA-4

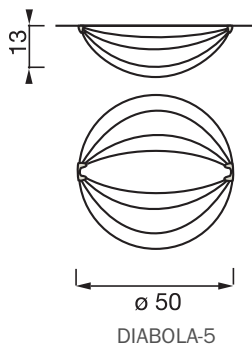

DIABOLA-5



16 Bianco White



28 Grigio-argento Silver grey



22 Ottone Brass



23 Cromo Chrome

Supporto in metallo verniciato, cornice in vetro colorato e diffusore in vetro satinato.

Painted metal back plate. Glass trim. Satin glass diffuser.

Support laqué, anneau et diffuseur en verre satiné.

Armatur aus lackiertem Metall, Ring und Glas seidenmatt.

Estructura de metal barnizado, marco con vidrio colorado y vidrio satinado.

Стеклянная отделка. Рассеиватель из матового стекла.



IP20

	TYPE	ELECTRIFICATION	SOCKET	LAMP	CODE	FINISHING
PARETE WALL	VIDRIO-A	42W	E27	A55	P033	05-10-17-18
SOFFITTO CEILING	VIDRIO-P3	52W	E27	A55	P036	05-10-17-18
SOFFITTO CEILING	VIDRIO-P4	2x42W	E27	A55	P037	05-10-17-18

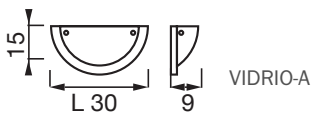

VIDRIO-P3

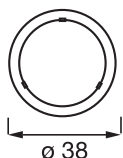

VIDRIO-P4



05 Cristallo satinato
Satined crystal



10 Azzurro
Light blue



17 Verde
Green



18 Rosa
Pink

Tree

Lampada da soffitto. Ceiling lamp. / Lampada da parete. Wall lamp.

Cornice in legno verniciata rovere o pino. Diffusore in vetro satinato.

Wood frame available in painted oak and pine. Satin glass diffuser.

Support en métal laqué, cadre en bois verni. Diffuseur en verre satiné.

Armaturo aus lackiertem Metall, Rahmen aus lackiertem Holz und Glas seidenmatt.

Marco barnisado roble o pino. Vidrio satinado.

Деревянная рамка из дуба или сосны Рассеиватель из матового стекла.



⊕ IP20 ⚡ CE

	TYPE	ELECTRIFICATION	SOCKET	LAMP	CODE	FINISHING
PARETE WALL	TREE-A	42W	E27	A55	P003	41 - 42
SOFFITTO CEILING	TREE-P3	52W	E27	A55	P004	41 - 42
SOFFITTO CEILING	TREE-P4	2x42W	E27	A55	P005	41 - 42
SOFFITTO CEILING	TREE-P5	2x52W	E27	A55	P006	41 - 42

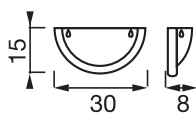

TREE-A



TREE-P3



TREE-P4



TREE-P5



41 Pino
Pine wood



42 Rovere
Oak wood

Supporto in metallo verniciato, cornice in legno, griglia di protezione in acciaio ottonato. Vetro satinato.

Painted metal back plate. Wood trim. Brass plated steel wire protection grate. Satin glass diffuser.

Support en métal laqué, cadre en bois, grille de protection en acier laitonné, diffuseur en verre satiné.

Armaturo aus lackiertem Metall, Rahmen aus Holz, Schutzgitter aus verchromtem Stahl, Glas seidenmatt.

Soporte de metal barnizado, marco de madera, rejilla de protección de acero bronceado con vidrio satinado.

Дерево. Латунная решетка. Рассеиватель из матового стекла.



Ⓛ IP40 ⚡ CE

	TYPE	ELECTRIFICATION	SOCKET	LAMP	CODE	FINISHING
PARETE/SOFFITTO WALL/CEILING	GABBIA-O	28W	E14	P45	P029	42
PARETE/SOFFITTO WALL/CEILING	GABBIA-T	28W	E14	P45	P038	42



GABBIA-T

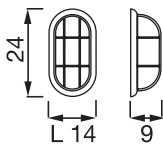



GABBIA-O







42 Rovere
Oak wood













Incandescent lamps

symbol	uni	wattage	socket	code
	A55	28W	E27	052665
	A55	42W	E27	052611
	A55	52W	E27	052612
	A55	70W	E27	052602
	A55	105W	E27	052666
	B35	28W	E14	052664
	P45	28W	E14	052609
	P45	42W	E14	052613

Halogen lamps

symbol	uni	wattage	socket	code
	QT-13	20W	G9	052532
	QT-13	33W	G9	052535
	QT-13	48W	G9	052540
	QT-14	60W	G9	052531
	QT-DE 78mm	80W	R7s	052533
	QT-DE 78mm	120W	R7s	052534
	QT-DE 118mm	120W	R7s	052536
	QT-DE 118mm	160W	R7s	052521
	QT-DE 118mm	230W	R7s	052522
	QPAR	50W	GU10	052530
	QPAR	75W	GU10	052527
	QT-32	70W	E27	052636
	QT-32	105W	E27	052637
	QT-32	205W	E27	052663

Fluorescent lamps

symbol	uni	wattage	socket	code
	TC-S	9W	G23	052564
	TC-SE	11W	2G7	052559
	TC-D	13W	G24d-1	052560
	TC-D	18W	G24d-2	052569
	TC-D	26W	G24d-3	052562
	TC-DE	18W	G24q-2	052563
	TC-DE	26W	G24q-3	052565
	TC-DD	16W	GR8	052561
	TC-DD	28W	GR8	052566
	TC-DDE	10W	GR10q	052570
	TC-DDE	28W	GR10q	052567
	TC-DDE	38W	GR10q	05256
	TC-L	18W	2G11	052622
	TC-L	24W	2G11	052621
	TC-L	36W	2G11	052624
	TC-L	55W	2G11	052650
	TC-F	24W	2G10	052604
	TC-F	36W	2G10	052608
	TC-TSE	14W	E27	052630
	TC-TSE	17W	E27	052528
	TC-TSE	21W	E27	052648
	TC-TSE	24W	E27	052638
	T16 (T5)	24W	G5	052625
	T16 (T5)	39W	G5	052623
	T16 (T5)	54W	G5	052649
	T5c	22W	2GX13	052639
	T5c	40W	2GX13	052641
	T5c	55W	2GX13	052640
	T-R	22W	G10q	052642
	T-R	32W	G10q	052644
	MICROLYNX_F	7W	GX53	052647
	MICROLYNX_F	9W	GX53	052662

CONFORMITA' - SIMBOLOGIE - CERTIFICAZIONI

CONFORMITIES - SYMBOLOGIES - CERTIFICATIONS

Tutti i prodotti di LUCENTE che rientrano nell'ambito di applicazione della direttiva europea EMC 89/336 e 93/68 EEC, soddisfano i requisiti richiesti e recano la marcatura CE . Il simbolo CE è posto sull'imballo del prodotto.

Nella continua ricerca di miglioramenti tecnici e funzionali, LUCENTE srl si riserva il diritto di apportare modifiche anche sostanziali ai propri prodotti, che potranno essere effettuate senza preavviso. Disegni, quote e colori sono da intendersi a titolo puramente indicativo e non sono impegnative per LUCENTE srl.

Il marchio KIWA è valido in tutto il mondo. Indica che l'azienda ha ottenuto la certificazione aziendale del Sistema di Qualità per quello che riguarda la progettazione, la produzione e la vendita di apparecchi di illuminazione. La norma di riferimento è di UNI EN ISO 9001.

All the products of LUCENTE meet with current European directives EMEC 89/336 and 93/68 EEC, meet their requirements and are CE marked. The symbol CE is placed on the packaging of the product.

In accordance with its policy of continuous products development LUCENTE reserves the right to modify its products without prior notice. Descriptions, charges and colours in this catalogue are indicative.

The Certificate KIWA is valid all over the world. It is there indicated that the company has obtained the Quality System Certificate for what concerns specification, production and distribution of lighting products. The regulation standard is UNI EN ISO 9001.



Certificato / Certificate n. KI-050168/01
(sistema qualità certificato / quality system UNI EN ISO 9001:2000)



Montaggio su superfici infiammabili
Direct mounting on normally flammable surfaces



Contatto di terra - Classe I
Earth contact – Class I



Doppio isolamento - Classe II
Double insulation – Class II

IP20 **IP20: Protezione contro l'ingresso di corpi solidi $\varnothing \geq 12\text{mm}$**
Protected against the penetration of solid bodies $\varnothing \geq 12\text{mm}$

IP30 **IP30: Protezione contro l'ingresso di corpi solidi $\varnothing \geq 2,5\text{ mm}$**
Protected against the penetration of solid bodies $\varnothing \geq 2,5\text{mm}$

IP40 **IP40: Protezione contro l'ingresso di corpi solidi $\varnothing \geq 1\text{mm}$**
Protected against the penetration of solid bodies $\varnothing \geq 1\text{mm}$



IP44 **IP44: Protezione contro l'ingresso di corpi solidi $\varnothing \geq 1\text{mm}$ e contro gli spruzzi**
Protected against the penetration of solid bodies $\varnothing \geq 1\text{mm}$ and against the squeezes



IP54 **IP54: Protezione contro l'ingresso della polvere e contro gli spruzzi d'acqua**
Protected against the penetration of dust and water splash

Direttiva RAEE: Rifiuti di Apparecchiature Elettriche ed Elettroniche

Il 25 Luglio 2005 il Consiglio dei Ministri ha recepito con Decreto Legislativo no 151 la Direttiva Europea 2002/95/CE e 2002/96/CE relativa alla riduzione delle sostanze pericolose nelle apparecchiature elettriche ed elettroniche e dello smaltimento dei rifiuti da essi derivanti.

L'obiettivo è promuovere una logica di sviluppo sostenibile nel settore delle apparecchiature elettriche ed elettroniche, di cui gli apparecchi di illuminazione ne fanno parte, ai fini di un corretto trattamento dei prodotti a fine vita e ciò può attuarsi attraverso la piena conformità alla Direttiva RAEE.

Il Produttore, come definito dal Dlgs no 151, dovrà farsi carico dei costi di gestione che comprendono la raccolta, presso gli impianti di stoccaggio provvisorio e dello smaltimento dei rifiuti degli apparecchi di illuminazione immessi sul mercato dopo l'Agosto 2006.

Per adempiere a questi obblighi di legge LUCENTE S.r.l. ha deciso di avvalersi del supporto di:
Consorzio ECOLIGHT,
Via Gattamelata 34,
20149 Milano Tel 02 33600732.



Gli apparecchi di illuminazione saranno marcati in modo da identificare il Produttore e riportare il simbolo del cassonetto barrato, indicante la raccolta differenziata separata dal resto dei rifiuti urbani, inoltre saranno soggetti al contributo di smaltimento, differenziato per fascia di peso.

Gli utenti finali potranno consegnare i suddetti apparecchi senza costi aggiuntivi presso i punti di raccolta appositamente realizzati e comunicati dal Consorzio. I distributori sono obbligati ad assicurare al momento della fornitura di una nuova apparecchiatura, il ritiro gratuito, in ragione di uno

ad uno, della apparecchiatura usata. L'obbligo di informazione relativo al contributo dovrà essere mantenuto visibile in fattura, da parte del Produttore, fino al 13 febbraio 2011.

I prodotti elencati con il relativo peso netto alla fine del presente catalogo saranno soggetti al contributo di smaltimento a seconda della fascia di peso di appartenenza:

- fascia 1: apparecchi il cui peso è compreso tra 0 e 2 Kg
- fascia 2: apparecchi il cui peso è compreso tra 2 e 8 Kg
- fascia 3: apparecchi il cui peso è superiore a 8 Kg

Direttiva RoHS

Il Decreto Legislativo sopra menzionato incorpora anche la Direttiva 2002/95/CE - RoHS - Limiti d'uso di alcune sostanze pericolose - relativa alla riduzione delle sostanze pericolose nelle apparecchiature elettriche ed elettroniche.

A partire dal 1° Luglio 2006 tutte le nuove apparecchiature elettriche ed elettroniche immesse sul mercato non dovranno contenere o contenere in misura limitata sostanze quali:

- Piombo
- Mercurio
- Cadmio
- Cromo esavalente
- Bifenile polibromurati (PBB)
- Eteri difendi polibromurati (PBDE)

WEEE Directive: Waste Electrical and Electronic Equipment

On the 25th July 2005, the Council of Ministers incorporated the European Directive 2002/95/CE and 2002/96/CE – related to the reduction of hazardous substances in electronic and electrical equipment and their waste disposal - into Italian legislation with the Legislative Decree number 151. The objective is that of promoting a notion of sustainable development within the electronic and electrical equipment sector, to which lighting equipment belongs, with the aim of correctly treating the products once they have reached the end of their lives; this may be accomplished by fully complying with the WEEE Directive. The Manufacturer, as defined by the Legislative Decree number 151, will be responsible for the management costs which include collection from temporary storage facilities and the costs for waste disposal of the lighting Equipment. In order to fulfil these legal obligations LUCENTE S.r.l. have decided to call upon the support of the ECOLIGHT Consortium;
Consorzio ECOLIGHT,
Via Gattamelata 34,
20149 Milan Tel. +39 02 3360 0732.



The lighting equipment will be marked in such a way as to identify the Manufacturer and show the symbol of the crossed wheeled bin, which indicates a separate collection from the rest of the urban waste, the equipment will also be subject to a disposal contribution and will be distinguishable by its weight range.

The contribution will be determined prior to the law coming into force and will be made official by the ECOLIGHT Consortium. The end users will be able to deliver the above-mentioned equipment without any add-on costs to the authorised collection sites as notified by the Consortium. Distributors are obliged to ensure a free take-back service of the used equipment, at the time of the supply of a new unit, on a one-to-one basis.

The Manufacturer has a duty to supply and maintain information related to the amount of contribution and this must be shown on invoices until 13th February 2011.

The products listed in this catalogue will be marked with range symbols. Each symbol should be shown against its relevant range within the following table and each range will be subject to a different disposal contribution

- range 1: the equipment weight which is between 0 and 2 kg
- range 2: the equipment weight which is between 2 up to 8kg
- range 3: the equipment weight which is over 8kg

The RoHS Directive

The above-mentioned Legislative Decree has also implemented the RoHS 2002/95/CE Directive. The Restriction of the use of certain Hazardous Substances (RoHS) in electrical and electronic equipment.

As from 1st July 2006, all new electrical and electronic equipment put on the market must not contain, or contain limited quantities of, certain substance, namely:

- Lead
- Mercury
- Cadmium
- Hexavalent chromium
- Polybromide biphenyls (PBBs)
- Polybromide diphenyl ethers (PBDEs)

Cod.		Pag.	Cod.		Pag.	Cod.		Pag.	Cod.		Pag.
P002-23	KOMET-P4	193	P066-18	FRAC-4	206	P226-28	SQUARE-3	91	T015-28	RHA-A	35
P003-41	TREE-A	210	P067-05	FRAC-5	206	P227-16	SQUARE-4	91	T017-28	RHA-AS	35
P003-42	TREE-A	210	P067-10	FRAC-5	206	P227-28	SQUARE-4	91	T018-28	RHA-P1	35
P004-41	TREE-P3	210	P067-17	FRAC-5	206	P228-16	SQUARE-4	91	T019-28	RHA-P2	35
P004-42	TREE-P3	210	P067-18	FRAC-5	206	P228-28	SQUARE-4	91	T021-28	RHA-S2	35
P005-41	TREE-P4	210	P076-01	LINA-A	55	P229-22	POCKET-P3	195	T023-28	RHA-T1	35
P005-42	TREE-P4	210	P076-16	LINA-A	55	P229-23	POCKET-P3	195	T024-28	RHA-T2	35
P006-41	TREE-P5	210	P076-43	LINA-A	55	P230-22	POCKET-P4	195	T026-28	POSI-S	25
P006-42	TREE-P5	210	P077-01	LINA-S1	55	P230-23	POCKET-P4	195	T027-28	POSI-TA	25
P007-16	GEO	207	P077-16	LINA-S1	55	P231-22	HOOK-P3	194	T028-28	POSI-TE	25
P007-28	GEO	207	P077-43	LINA-S1	55	P231-23	HOOK-P3	194	T029-28	POSI-A	25
P007-43	GEO	207	P078-16	LINA-S2	55	P232-22	HOOK-P4	194	T040-23	NAU-A1C	69
P008-16	MOON	207	P079-01	LINA-TA	55	P232-23	HOOK-P4	194	T040-34	NAU-A1C	69
P008-28	MOON	207	P079-16	LINA-TA	55	P233	OSTER-P3	187	T041-23	NAU-A1K	69
P009-16	BREAK	208	P079-43	LINA-TA	55	P234	OSTER-P4	187	T041-34	NAU-A1K	69
P009-28	BREAK	208	P080-16	LINA-TE	55	P235	OSTER-P4	187	T042-23	NAU-A2C	69
P010-16	DIECI-P3	192	P081-22	LUNA-2	156	P236	OSTER-P4	187	T042-34	NAU-A2C	69
P010-22	DIECI-P3	192	P081-23	LUNA-2	156	P237-12	NUVOLA	153	T043-23	NAU-A2K	69
P010-23	DIECI-P3	192	P082-22	LUNA-3	156	P237-16	NUVOLA	153	T043-34	NAU-A2K	69
P011-16	DIECI-P4	192	P082-23	LUNA-3	156	P237-43	NUVOLA	153	T044-23	NAU-A3C	69
P011-22	DIECI-P4	192	P085-16	ISOTTA	164	P238-16	SAIL	153	T044-34	NAU-A3C	69
P011-23	DIECI-P4	192	P085-43	ISOTTA	164	P239-16	SAMURAI	153	T045-23	NAU-A3K	69
P012-16	DIECI-A	192	P086-01	MIZAR-3	201	P240-16	VIDEO-3	200	T045-34	NAU-A3K	69
P012-22	DIECI-A	192	P086-16	MIZAR-3	201	P240-28	VIDEO-3	200	T046-23	NAU-A4C	69
P012-23	DIECI-A	192	P086-43	MIZAR-3	201	P241-16	VIDEO-4	200	T046-34	NAU-A4C	69
P013-16	STADIUM	157	P087-01	MIZAR-4	201	P241-28	VIDEO-4	200	T047-23	NAU-A4K	69
P014-22	POCKET-A	195	P087-16	MIZAR-4	201	P242-16	SQUARE-4	91	T047-34	NAU-A4K	69
P014-23	POCKET-A	195	P087-43	MIZAR-4	201	P242-28	SQUARE-4	91	T050-23	NAU-S1C	69
P015-22	POCKET-P3	195	P090-22	QUADRA	203	P243-16	SQUARE-5	91	T050-34	NAU-S1C	69
P015-23	POCKET-P3	195	P090-23	QUADRA	203	P243-28	SQUARE-5	91	T051-23	NAU-S1K	69
P016-22	POCKET-P4	195	P093-16	VIDEO-3	200	P244-16	SQUARE-6	91	T051-34	NAU-S1K	69
P016-23	POCKET-P4	195	P093-28	VIDEO-3	200	P244-28	SQUARE-6	91	T052-23	NAU-S2C	69
P017-22	HOOK-A	194	P094-16	VIDEO-4	200	P245-16	SQUARE-7	91	T052-34	NAU-S2C	69
P017-23	HOOK-A	194	P094-28	VIDEO-4	200	P245-28	SQUARE-7	91	T053-23	NAU-S2K	69
P018-22	HOOK-P3	194	P095-15	RANDA-TA	163	P246-16	SQUARE-7	91	T053-34	NAU-S2K	69
P018-23	HOOK-P3	194	P095-17	RANDA-TA	163	P246-28	SQUARE-7	91	T054-23	NAU-S3C	69
P019-22	HOOK-P4	194	P095-28	RANDA-TA	163	P248-22	POCKET-P4	195	T054-34	NAU-S3C	69
P019-23	HOOK-P4	194	P096-15	RANDA-TE	163	P248-23	POCKET-P4	195	T055-23	NAU-S3K	69
P020-16	DIECI-P3	192	P096-28	RANDA-TE	163	P249-22	HOOK-P4	195	T055-34	NAU-S3K	69
P020-22	DIECI-P3	192	P098-28	SATURNO	204	P249-23	HOOK-P4	195	T056-23	NAU-S4C	69
P020-23	DIECI-P3	192	P099-22	GALASSIA-3	199	P253-16	VIDEO-4	200	T056-34	NAU-S4C	69
P021-16	DIECI-P4	192	P099-23	GALASSIA-3	199	P253-28	VIDEO-4	200	T057-23	NAU-S4K	69
P021-22	DIECI-P4	192	P099-29	GALASSIA-3	199	P254-16	SQUARE-8	91	T057-34	NAU-S4K	69
P021-23	DIECI-P4	192	P100-22	GALASSIA-4	199	P254-28	SQUARE-8	91	T060-28	BOREALE-T3	99
P022-16	DIECI-A	192	P100-23	GALASSIA-4	199	P255-16	SQUARE-8	91	T061-28	BOREALE-T4	99
P022-22	DIECI-A	192	P100-29	GALASSIA-4	199	P255-28	SQUARE-8	91	T062-28	BOREALE-03	99
P022-23	DIECI-A	192	P101-16	RING-3	197	P256-16	SQUARE-8	91	T063-28	BOREALE-04	99
P023-12	NUVOLA	153	P101-22	RING-3	197	P256-28	SQUARE-8	91	T064-28	BOREALE-03	99
P023-16	NUVOLA	153	P101-23	RING-3	197	P257-16	RING-5	197	T065-28	BOREALE-04	99
P023-43	NUVOLA	153	P102-16	RING-4	197	P257-22	RING-5	197	T070-16	AI-PI - P3	169
P025-16	SAIL	153	P102-22	RING-4	197	P257-23	RING-5	197	T070-23	AI-PI - P3	169
P026-16	SAMURAI	153	P102-23	RING-4	197	P258-16	RING-5	197	T070-28	AI-PI - P3	169
P029-42	GABBIA-0	211	P103-16	RING-4	197	P258-22	RING-5	197	T070-34	AI-PI - P3	169
P030-16	SQUARE-3	91	P103-22	RING-4	197	P258-23	RING-5	197	T071-16	AI-PI - P3	169
P030-28	SQUARE-3	91	P103-23	RING-4	197	P259-16	RING-5	197	T071-23	AI-PI - P3	169
P031-16	SQUARE-4	91	P105-16	DIECI-P3	192	P259-22	RING-5	197	T071-28	AI-PI - P3	169
P031-28	SQUARE-4	91	P105-22	DIECI-P3	192	P259-23	RING-5	197	T071-34	AI-PI - P3	169
P032-01	BRACKET	202	P105-23	DIECI-P3	192	P260-16	RING-5	197	T072-16	AI-PI - P3	169
P032-16	BRACKET	202	P108-22	SORRISO-3	204	P260-22	RING-5	197	T072-23	AI-PI - P3	169
P033-05	VIDRIO-A	209	P108-27	SORRISO-3	204	P260-23	RING-5	197	T072-28	AI-PI - P3	169
P033-10	VIDRIO-A	209	P109-22	SORRISO-4	204	P261-16	DIECI-P5	192	T072-34	AI-PI - P3	169
P033-17	VIDRIO-A	209	P109-27	SORRISO-4	204	P261-22	DIECI-P5	192	T075-16	AI-PI - P4	169
P033-18	VIDRIO-A	209	P115-16	VIDEO-3	200	P261-23	DIECI-P5	192	T075-23	AI-PI - P4	169
P034-23	KOMET-A	193	P115-28	VIDEO-3	200	P262-16	DIECI-P5	192	T075-28	AI-PI - P4	169
P035-23	KOMET-P3	193	P116-16	VIDEO-4	200	P262-22	DIECI-P5	192	T075-34	AI-PI - P4	169
P036-05	VIDRIO-P3	209	P116-28	VIDEO-4	200	P262-23	DIECI-P5	192	T076-16	AI-PI - P4	169
P036-10	VIDRIO-P3	209	P216-04	TRIANGOLI	187	P263-16	DIECI-P5	192	T076-23	AI-PI - P4	169
P036-17	VIDRIO-P3	209	P216-12	TRIANGOLI	187	P263-22	DIECI-P5	192	T076-28	AI-PI - P4	169
P036-18	VIDRIO-P3	209	P216-23	TRIANGOLI	187	P263-23	DIECI-P5	192	T076-34	AI-PI - P4	169
P037-05	VIDRIO-P4	209	P216-28	TRIANGOLI	187	P264-16	DIECI-P5	192	T077-16	AI-PI - P4	169
P037-10	VIDRIO-P4	209	P217-04	FIORE	187	P264-22	DIECI-P5	192	T077-23	AI-PI - P4	169
P037-17	VIDRIO-P4	209	P217-12	FIORE	187	P264-23	DIECI-P5	192	T077-28	AI-PI - P4	169
P037-18	VIDRIO-P4	209	P217-23	FIORE	187	P265-22	HOOK-P5	194	T077-34	AI-PI - P4	169
P038-42	GABBIA-T	211	P217-28	FIORE	187	P265-23	HOOK-P5	194	T090-28	AIDA-P3	97
P040-22	DIABOLA-4	208	P218-04	TRIANGOLI	187	P266-22	HOOK-P5	194	T091-28	AIDA-P3	97
P040-23	DIABOLA-4	208	P218-12	TRIANGOLI	187	P266-23	HOOK-P5	194	T092-28	AIDA-P4	97
P041-22	DIABOLA-5	208	P218-23	TRIANGOLI	187	P267-22	HOOK-P5	194	T093-28	AIDA-P4	97
P041-23	DIABOLA-5	208	P218-28	TRIANGOLI	187	P267-23	HOOK-P5	194	T109-24	OMNIP	198
P045-16	DAMA	205	P219-04	FIORE	187	P268-22	HOOK-P5	194	T110-23	JOLE-A	151
P046-16	TRIANGOLI	205	P219-12	FIORE	187	P268-23	HOOK-P5	194	T111-23	JOLE-A	151
P050-14	HUT	191	P219-23	FIORE	187	P269-22	POCKET-P5	195	T115-23	ALTEA-A	47
P050-16	HUT	191	P219-28	FIORE	187	P269-23	POCKET-P5	195	T116-23	ALTEA-S1	47
P050-29	HUT	191	P220	OSTER-P3	187	P270-22	POCKET-P5	195	T117-23	ALTEA-S2	47
P050-43	HUT	191	P221	OSTER-P3	187	P270-23	POCKET-P5	195	T118-23	ALTEA-T	47
P051-14	BIG HUT	191	P222-16	RING-4	197	P271-22	POCKET-P5	195	T119-23	CLUB-S	81
P051-16	BIG HUT	191	P222-22	RING-4	197	P271-23	POCKET-P5	195	T120-23	ROCK-A	51
P051-29	BIG HUT	191	P222-23	RING-4	197	P272-22	POCKET-P5	195	T121-23	ROCK-S2	51
P051-43	BIG HUT	191	P223-22	GALASSIA-4	199	P272-23	POCKET-P5	195	T122-23	ROCK-S4	51
P053-39	IRISH	206	P223-23	GALASSIA-4	199	T001-28	METI-A	41	T123-23	ROCK-TE	51
P065-05	FRAC-3	206	P223-29	GALASSIA-4	199	T002-28	METI-A	41	T124-23	ROCK-TA	51
P065-10	FRAC-3	206	P224-22	GALASSIA-4	199	T003-28	METI-P	41	T125-24	HOT-A1	125
P065-17	FRAC-3	206	P224-23	GALASSIA-4	199	T004-28	METI-P	41	T125-28	HOT-A1	125
P065-18	FRAC-3	206	P224-29	GALASSIA-4	199	T005-28	METI-S	41	T126-24	HOT-A2	125
P066-05	FRAC-4	206	P225-16	SQUARE-3	91	T006-28	METI-S	41	T126-28	HOT-A2	125
P066-10	FRAC-4	206	P225-28	SQUARE-3	91	T010-28	METI-T	41	T127-24	HOT-A3	125
P066-17	FRAC-4	206	P226-16	SQUARE-3	91	T011-28	METI-T	41	T127-28	HOT-A3	125

Cod.		Pag.	Cod.		Pag.	Cod.		Pag.	Cod.		Pag.
T128-23	FLUONIGHT-A1	129	T180-16	BRIGHT-A2	141	T234-16	AI-PI - P5	169	T288-16	GLEN	107
T128-28	FLUONIGHT-A1	129	T181-01	BRIGHT-A2	141	T234-28	AI-PI - P5	169	T288-28	GLEN	107
T129-23	FLUONIGHT-A2	129	T181-14	BRIGHT-A2	141	T234-34	AI-PI - P5	169	T289	ASTRATTA	83
T129-28	FLUONIGHT-A2	129	T181-15	BRIGHT-A2	141	T235-15	SQ-EASY-P3	175	T290	ASTRATTA	83
T130-23	FLUONIGHT-A2	129	T181-16	BRIGHT-A2	141	T235-16	SQ-EASY-P3	175	T291	ASTRATTA	83
T130-28	FLUONIGHT-A2	129	T182-01	BRIGHT-A3	141	T235-28	SQ-EASY-P3	175	T292	ASTRATTA	83
T131-23	FLUONIGHT-A3	129	T182-14	BRIGHT-A3	141	T240-23	ZAC-P3	111	T293	ASTRATTA	83
T131-28	FLUONIGHT-A3	129	T182-15	BRIGHT-A3	141	T240-34	ZAC-P3	111	T294	ASTRATTA	83
T132-23	GEA-A1	123	T182-16	BRIGHT-A3	141	T241-23	ZAC-P4	111	T295	ASTRATTA	83
T133-23	GEA-A1	123	T183-16	GAIA-A1	145	T241-34	ZAC-P4	111	T296	ASTRATTA	83
T134-23	GEA-A2	123	T184-16	GAIA-A1	145	T245-23	ONSEN-A1T	185	T297-02	GINGER -P1	5
T135-23	GEA-A2	123	T185-16	GAIA-A2	145	T245-34	ONSEN-A1T	185	T297-14	GINGER -P1	5
T136-28	DOMINO-A1	133	T186-16	GAIA-A3	145	T247-23	ONSEN-A1B	185	T297-15	GINGER -P1	5
T137-28	DOMINO-A2	133	T187-14	GAIA-A1	145	T247-34	ONSEN-A1B	185	T298-02	GINGER -P2	5
T138-28	DOMINO-A3	133	T187-16	GAIA-A1	145	T249-23	ONSEN-A2T	185	T298-14	GINGER -P2	5
T139-28	DOMINO-A4	133	T187-43	GAIA-A1	145	T249-34	ONSEN-A2T	185	T298-15	GINGER -P2	5
T140-28	DOMINO-A4	133	T188-14	GAIA-A1	145	T251-23	ONSEN-A2B	185	T299-02	GINGER-S1	5
T141-25	AI-PI - P3	169	T188-16	GAIA-A1	145	T251-34	ONSEN-A2B	185	T299-14	GINGER-S1	5
T142-25	AI-PI - P3	169	T188-43	GAIA-A1	145	T252-16	JEFA1	115	T299-15	GINGER-S1	5
T143-25	AI-PI - P3	169	T189-14	GAIA-A2	145	T252-23	JEFA1	115	T300-02	GINGER-S2	5
T144-25	AI-PI - P4	169	T189-16	GAIA-A2	145	T252-34	JEFA1	115	T300-14	GINGER-S2	5
T145-25	AI-PI - P4	169	T189-43	GAIA-A2	145	T253-16	JEFA2	115	T300-15	GINGER-S2	5
T146-25	AI-PI - P4	169	T190-14	GAIA-A3	145	T253-23	JEFA2	115	T301-02	GINGER ARCO	5
T147-16	AI-PI - P1	169	T190-16	GAIA-A3	145	T253-34	JEFA2	115	T301-14	GINGER ARCO	5
T147-23	AI-PI - P1	169	T190-43	GAIA-A3	145	T254-16	JEFA3	115	T301-15	GINGER ARCO	5
T147-28	AI-PI - P1	169	T191-16	AI-PI - P4	169	T254-23	JEFA3	115			
T147-34	AI-PI - P1	169	T191-23	AI-PI - P4	169	T254-34	JEFA3	115			
T148-25	AI-PI - P1	169	T191-28	AI-PI - P4	169	T255-16	JEF1	115			
T149-01	ELLA-A	75	T191-34	AI-PI - P4	169	T255-23	JEF1	115			
T149-04	ELLA-A	75	T192-25	AI-PI - P4	169	T255-34	JEF1	115			
T149-16	ELLA-A	75	T193-28	POSI W-TE	25	T256-16	JEF2	115			
T150-01	ELLA-S	75	T194-28	POSI W-TA	25	T256-23	JEF2	115			
T150-04	ELLA-S	75	T195-28	POSI W-A	25	T256-34	JEF2	115			
T150-16	ELLA-S	75	T196-28	POSI W-S	25	T257-16	ARGO-A	137			
T151-01	KLYPTA-A	149	T197-28	EMY-TE	65	T258-16	ARGO-A	137			
T151-16	KLYPTA-A	149	T198-28	EMY-TA	65	T259-23	FLOAT-A1	183			
T152-28	O-LAMP	103	T199-28	EMY-A	65	T259-34	FLOAT-A1	183			
T153-28	O-LAMP	103	T200-28	EMY-S	65	T260-23	FLOAT-A2	183			
T154-28	EOS-P3	173	T201-01	BELL-S	79	T260-34	FLOAT-A2	183			
T155-28	EOS-P3	173	T201-04	BELL-S	79	T261-02	GINGER -P1	5			
T156-28	EOS-P3	173	T201-16	BELL-S	79	T261-14	GINGER -P1	5			
T157-28	EOS-P4	173	T201-17	BELL-S	79	T261-15	GINGER -P1	5			
T158-28	EOS-P4	173	T202-28	TWIST-A1	89	T262-02	GINGER -P2	5			
T159-28	EOS-P4	173	T203-28	TWIST-A1	89	T262-14	GINGER -P2	5			
T160-24	OMNI-P	198	T204-28	TWIST-A2	89	T262-15	GINGER -P2	5			
T161-24	OMNI-P	198	T205-28	TWIST-A2	89	T263-02	GINGER-S1	5			
T162-01	OLYMPIA-TA	13	T206-28	TWIST-A3	89	T263-14	GINGER-S1	5			
T162-04	OLYMPIA-TA	13	T207-28	TWIST-A3	89	T263-15	GINGER-S1	5			
T162-16	OLYMPIA-TA	13	T208-28	TWIST-4	89	T264-02	GINGER-S2	5			
T163-01	OLYMPIA-A	13	T209-28	TWIST-4	89	T264-14	GINGER-S2	5			
T163-04	OLYMPIA-A	13	T210-28	TWIST-5	89	T264-15	GINGER-S2	5			
T163-16	OLYMPIA-A	13	T211-28	TWIST-5	89	T265-02	GINGER-TA	5			
T164-01	OLYMPIA-TE	13	T212-16	DUPLEX-A1	21	T265-14	GINGER-TA	5			
T164-04	OLYMPIA-TE	13	T212-44	DUPLEX-A1	21	T265-15	GINGER-TA	5			
T164-16	OLYMPIA-TE	13	T213-16	DUPLEX-A2	21	T266-02	GINGER-TE	5			
T165-01	OLYMPIA-S1	13	T213-44	DUPLEX-A2	21	T266-14	GINGER-TE	5			
T165-04	OLYMPIA-S1	13	T214-16	DUPLEX-S1	21	T266-15	GINGER-TE	5			
T165-16	OLYMPIA-S1	13	T214-44	DUPLEX-S1	21	T267-15	IDROO-P1	179			
T166-01	OLYMPIA-S1	13	T215-16	DUPLEX-S2	21	T267-16	IDROO-P1	179			
T166-04	OLYMPIA-S1	13	T215-44	DUPLEX-S2	21	T267-28	IDROO-P1	179			
T166-16	OLYMPIA-S1	13	T216-16	DUPLEX-S3	21	T268-15	IDROO-P1	179			
T167-01	OLYMPIA-A1	13	T216-44	DUPLEX-S3	21	T268-16	IDROO-P1	179			
T167-04	OLYMPIA-A1	13	T217-16	DUPLEX-TE	21	T268-28	IDROO-P1	179			
T167-16	OLYMPIA-A1	13	T217-44	DUPLEX-TE	21	T269-15	IDROO-P2	179			
T168-01	OLYMPIA-A1	13	T218-16	OLLY-P1	31	T269-16	IDROO-P2	179			
T168-04	OLYMPIA-A1	13	T219-16	OLLY-P2	31	T269-28	IDROO-P2	179			
T168-16	OLYMPIA-A1	13	T220-16	OLLY-P3	31	T270-16	TRIM-A1	85			
T169-01	OLYMPIA-TE-1	13	T221-16	OLLY-S1	31	T271-16	TRIM-A2	85			
T169-04	OLYMPIA-TE-1	13	T222-16	OLLY-S2	31	T272-16	TRIM-P1	85			
T169-16	OLYMPIA-TE-1	13	T223-16	OLLY-S3	31	T273-16	TRIM-P1	85			
T170-01	OLYMPIA-TE-1	13	T224-16	OLLY-TA1	31	T274-16	TRIM-P1	85			
T170-04	OLYMPIA-TE-1	13	T225-16	OLLY-TA2	31	T275-16	ZAC-P3	111			
T170-16	OLYMPIA-TE-1	13	T226-15	SQ-EASY-P3	175	T275-28	ZAC-P3	111			
T171-01	OLYMPIA-S2	13	T226-16	SQ-EASY-P3	175	T276-16	ZAC-P4	111			
T171-04	OLYMPIA-S2	13	T226-28	SQ-EASY-P3	175	T276-28	ZAC-P4	111			
T171-16	OLYMPIA-S2	13	T227-15	SQ-EASY-P3	175	T277-25	BAAN-LINEA-1	121			
T172-01	OLYMPIA-S2	13	T227-16	SQ-EASY-P3	175	T278-25	BAAN-LINEA1	121			
T172-04	OLYMPIA-S2	13	T227-28	SQ-EASY-P3	175	T279-25	BAAN-FORI-1	121			
T172-16	OLYMPIA-S2	13	T228-15	SQ-EASY-P3	175	T280-25	BAAN-FORI-1	121			
T173-01	OLYMPIA-TE2	13	T228-16	SQ-EASY-P3	175	T281-16	TRIM-A1	85			
T173-04	OLYMPIA-TE2	13	T228-28	SQ-EASY-P3	175	T282-16	TRIM-A2	85			
T173-16	OLYMPIA-TE2	13	T229-15	SQ-EASY-P3	175	T283-15	TAIA-TAB	159			
T174-01	OLYMPIA-TE2	13	T229-16	SQ-EASY-P3	175	T283-28	TAIA-TAB	159			
T174-04	OLYMPIA-TE2	13	T229-28	SQ-EASY-P3	175	T284-15	TAIA-FLO	159			
T174-16	OLYMPIA-TE2	13	T230-01	ELLA-S2	75	T284-28	TAIA-FLO	159			
T175-25	BAAN-LINEA-2	121	T230-04	ELLA-S2	75	T285-02	GINGER ARCO	5			
T176-25	BAAN-LINEA-2	121	T230-16	ELLA-S2	75	T285-14	GINGER ARCO	5			
T177-25	BAAN-FORI-2	121	T231-16	AI-PI - P5	169	T285-15	GINGER ARCO	5			
T178-25	BAAN-FORI-2	121	T231-28	AI-PI - P5	169	T286-06	ANKE	61			
T179-01	BRIGHT-A1	141	T231-34	AI-PI - P5	169	T286-07	ANKE	61			
T179-14	BRIGHT-A1	141	T232-16	AI-PI - P5	169	T286-15	ANKE	61			
T179-15	BRIGHT-A1	141	T232-28	AI-PI - P5	169	T286-16	ANKE	61			
T179-16	BRIGHT-A1	141	T232-34	AI-PI - P5	169	T287-06	ANKE	61			
T180-01	BRIGHT-A2	141	T233-16	AI-PI - P5	169	T287-07	ANKE	61			
T180-14	BRIGHT-A2	141	T233-28	AI-PI - P5	169	T287-15	ANKE	61			
T180-15	BRIGHT-A2	141	T233-34	AI-PI - P5	169	T287-16	ANKE	61			

Poomlighting

by LUCENTE®

Lucente srl

Via Piemonte 1/A
31038 Padernello di Paese
Treviso - Italy
Tel. +39 0422 4575
Fax +39 0422 950720

info@lucente.eu
www.lucente.eu